

Chapter 5.1

General provisions

5.1.1 Application and general provisions

This Part sets forth the provisions for dangerous goods consignments relative to marking, labelling, and documentation, and, where appropriate, authorization of consignments and advance notifications.

5.1.2 Use of overpacks

5.1.2.1

(a) An overpack shall be:

- (i) marked with the word "OVERPACK"; and
- (ii) marked with the UN number preceded by the letters "UN", and labelled as required for packages in 5.2.2, for each item of dangerous goods contained in the overpack,

unless the UN numbers and the labels representative of all dangerous goods contained in the overpack are visible, except as required in 5.2.2.1.11. If the same UN number or the same label is required for different packages, it only needs to be applied once.

The marking of the word "OVERPACK", which shall be readily visible and legible, shall be in an official language of the country of origin and also, if that language is not English, French or German, in English, French or German, unless any agreements concluded between the countries concerned in the transport operation provide otherwise.

(b) Orientation arrows illustrated in 5.2.1.9 shall be displayed on two opposite sides of the following overpacks:

- (i) overpacks containing packages which shall be labelled in accordance with 5.2.1.9.1, unless the marking remains visible, and
- (ii) overpacks containing liquids in packages which need not be marked in accordance with 5.2.1.9.2, unless the closures remain visible.

5.1.2.2

Each package of dangerous goods contained in an overpack shall comply with all applicable provisions of RID. The intended function of each package shall not be impaired by the overpack.

5.1.2.3

Each package bearing package orientation markings as prescribed in 5.2.1.9 and which is overpacked or placed in a large packaging shall be oriented in accordance with such markings.

5.1.2.4

The prohibitions on mixed loading also apply to these overpacks.

5.1.3

Empty uncleaned packagings (including IBCs and large packagings), tanks, wagons and containers for carriage in bulk

5.1.3.1

Empty uncleaned packagings (including IBCs and large packagings), tanks (including tank-wagons, battery-wagons, demountable tanks, portable tanks, tank-containers, MEGCs), wagons and containers for carriage in bulk having contained dangerous goods of the different classes other than Class 7, shall be marked and labelled as if they were full.

NOTE: For documentation, see Chapter 5.4.

5.1.3.2

Packagings, including IBCs, and tanks used for the carriage of radioactive material shall not be used for the storage or carriage of other goods unless decontaminated below the level of 0.4 Bq/cm² for beta and gamma emitters and low toxicity alpha emitters and 0.04 Bq/cm² for all other alpha emitters.

5.1.4

Mixed packing

When two or more dangerous goods are packed within the same outer packaging, the package shall be labelled and marked as required for each substance or article. If the same label is required for different goods, it only needs to be applied once.

5.1.5

General provisions for Class 7

5.1.5.1

Approval of shipments and notification

5.1.5.1.1

General

In addition to the approval for package designs described in Chapter 6.4, multilateral shipment approval is also required in certain circumstances (5.1.5.1.2 and 5.1.5.1.3). In some circumstances it is also necessary to notify competent authorities of a shipment (5.1.5.1.4).

5.1.5.1.2 Shipment approvals

Multilateral approval shall be required for:

- (a) the shipment of Type B(M) packages not conforming with the requirements of 6.4.7.5 or designed to allow controlled intermittent venting;
- (b) the shipment of Type B(M) packages containing radioactive material with an activity greater than 3000 A₁ or 3000 A₂, as appropriate, or 1000 TBq, whichever is the lower;
- (c) the shipment of packages containing fissile materials if the sum of the criticality safety indexes of the packages in a single wagon or container exceeds 50;

except that a competent authority may authorize carriage into or through its country without shipment approval, by a specific provision in its design approval (see 5.1.5.2.1).

5.1.5.1.3 Shipment approval by special arrangement

Provisions may be approved by a competent authority under which a consignment, which does not satisfy all of the applicable requirements of RID may be carried under special arrangement (see 1.7.4).

5.1.5.1.4 Notifications

Notification to competent authorities is required as follows:

- (a) Before the first shipment of any package requiring competent authority approval, the consignor shall ensure that copies of each applicable competent authority certificate applying to that package design have been submitted to the competent authority of the country of origin of the shipment and to the competent authority of each country through or into which the consignment is to be carried. The consignor is not required to await an acknowledgement from the competent authority, nor is the competent authority required to make such acknowledgement of receipt of the certificate;

- (b) For each of the following types of shipments:

- (i) Type C packages containing radioactive material with an activity greater than 3000 A₁ or 3000 A₂, as appropriate, or 1000 TBq, whichever is the lower;
- (ii) Type B(U) packages containing radioactive material with an activity greater than 3000 A₁ or 3000 A₂, as appropriate, or 1000 TBq, whichever is the lower;
- (iii) Type B(M) packages;
- (iv) Shipment under special arrangement;

The consignor shall notify the competent authority of the country of origin of the shipment and the competent authority of each country through or into which the consignment is to be carried. This notification shall be in the hands of each competent authority prior to the commencement of the shipment, and preferably at least 7 days in advance;

- (c) The consignor is not required to send a separate notification if the required information has been included in the application for shipment approval;
- (d) The consignment notification shall include:

- (i) sufficient information to enable the identification of the package or packages including all applicable certificate numbers and identification marks;
- (ii) information on the date of shipment, the expected date of arrival and proposed routing;
- (iii) the name(s) of the radioactive material(s) or nuclide(s);
- (iv) descriptions of the physical and chemical forms of the radioactive material, or whether it is special form radioactive material or low dispersible radioactive material; and
- (v) the maximum activity of the radioactive contents during carriage expressed in becquerels (Bq) with an appropriate SI prefix symbol (see 1.2.2.1). For fissile material, the mass of fissile material (or of each fissile nuclide for mixtures when appropriate) in grams (g), or multiples thereof, may be used in place of activity.

5.1.5.2 Certificates issued by the competent authority

5.1.5.2.1 Certificates issued by the competent authority are required for the following:

- (a) Designs for:

- (i) special form radioactive material;
- (ii) low dispersible radioactive material;
- (iii) packages containing 0.1 kg or more of uranium hexafluoride;
- (iv) all packages containing fissile material unless excepted by 6.4.11.2;
- (v) Type B(U) packages and Type B(M) packages;
- (vi) Type C packages;

- (b) Special arrangements;

(c) Certain shipments (see 5.1.5.1.2).

The certificates shall confirm that the applicable requirements are met, and for design approvals shall attribute to the design an identification mark.

The package design and shipment approval certificates may be combined into a single certificate.

Certificates and applications for these certificates shall be in accordance with the requirements in 6.4.23.

5.1.5.2.2 The consignor shall be in possession of a copy of each applicable certificate.

5.1.5.2.3 For package designs where a competent authority issued certificate is not required, the consignor shall, on request, make available for inspection by the competent authority, documentary evidence of the compliance of the package design with all the applicable requirements.

5.1.5.3 Determination of transport index (TI) and criticality safety index (CSI)

5.1.5.3.1 The transport index (TI) for a package, overpack or container, or for unpackaged LSA-I or SCO-I, shall be the number derived in accordance with the following procedure:

(a) Determine the maximum radiation level in units of millisieverts per hour (mSv/h) at a distance of 1 m from the external surfaces of the package, overpack, container, or unpackaged LSA-I and SCO-I. The value determined shall be multiplied by 100 and the resulting number is the transport index.

For uranium and thorium ores and their concentrates, the maximum radiation level at any point 1 m from the external surface of the load may be taken as:

0.4 mSv/h for ores and physical concentrates of uranium and thorium;

0.3 mSv/h for chemical concentrates of thorium;

0.02 mSv/h for chemical concentrates of uranium, other than uranium hexafluoride;

(b) For tanks, containers and unpackaged LSA-I and SCO-I, the value determined in step (a) above shall be multiplied by the appropriate factor from Table 5.1.5.3.1;

(c) The value obtained in steps (a) and (b) above shall be rounded up to the first decimal place (e.g. 1.13 becomes 1.2), except that a value of 0.05 or less may be considered as zero.

Table 5.1.5.3.1: Multiplication factors for tanks, containers and unpackaged LSA-I and SCO-I

Size of load ^(a)	Multiplication factor
size of load $\leq 1 \text{ m}^2$	1
$1 \text{ m}^2 < \text{size of load} \leq 5 \text{ m}^2$	2
$5 \text{ m}^2 < \text{size of load} \leq 20 \text{ m}^2$	3
$20 \text{ m}^2 < \text{size of load}$	10

(a) Largest cross-sectional area of the load being measured.

5.1.5.3.2 The transport index for each overpack, container or wagon shall be determined as either the sum of the TIs of all the packages contained, or by direct measurement of radiation level, except in the case of non-rigid overpacks for which the transport index shall be determined only as the sum of the TIs of all the packages.

5.1.5.3.3 The criticality safety index for each overpack or container shall be determined as the sum of the CSIs of all the packages contained. The same procedure shall be followed for determining the total sum of the CSIs in a consignment or aboard a wagon.

5.1.5.3.4 Packages and overpacks shall be assigned to either category I-WHITE, II-YELLOW or III-YELLOW in accordance with the conditions specified in Table 5.1.5.3.4 and with the following requirements:

(a) For a package or overpack, both the transport index and the surface radiation level conditions shall be taken into account in determining which is the appropriate category. Where the transport index satisfies the condition for one category but the surface radiation level satisfies the condition for a different category, the package or overpack shall be assigned to the higher category. For this purpose, category I-WHITE shall be regarded as the lowest category;

(b) The transport index shall be determined following the procedures specified in 5.1.5.3.1 and 5.1.5.3.2;

(c) If the surface radiation level is greater than 2 mSv/h, the package or overpack shall be carried under exclusive use and under the provisions of 7.5.11, CW 33 (3.5) (a);

(d) A package carried under a special arrangement shall be assigned to category III-YELLOW except **under the provisions of 5.1.5.3.5**;

(e) An overpack which contains packages carried under special arrangement shall be assigned to category III-YELLOW except **under the provisions of 5.1.5.3.5**.

Table 5.1.5.3.4: Categories of packages and overpacks

Conditions		Category
Transport index (TI)	Maximum radiation level at any point on external surface	
0 ^(a)	Not more than 0.005 mSv/h	I-WHITE
More than 0 but not more than 1 ^(a)	More than 0.005 mSv/h but not more than 0.5 mSv/h	II-YELLOW
More than 1 but not more than 10	More than 0.5 mSv/h but not more than 2 mSv/h	III-YELLOW
More than 10	More than 2 mSv/h but not more than 10 mSv/h	III- YELLOW ^(b)

(a) If the measured TI is not greater than 0.05, the value quoted may be zero in accordance with 5.1.5.3.1 (c).

(b) Shall also be carried under exclusive use.

5.1.5.3.5 In all cases of international carriage of packages requiring competent authority design or shipment approval, for which different approval types apply in the different countries concerned by the shipment, the categorization shall be in accordance with the certificate of the country of origin of design.

5.1.5.4 Specific provisions for excepted packages

5.1.5.4.1 Excepted packages shall be legibly and durably marked on the outside of the packaging with:

- (a) The UN number preceded by the letters "UN";
- (b) An identification of either the consignor or consignee, or both; and
- (c) The permissible gross mass if this exceeds 50 kg.

5.1.5.4.2 The documentation requirements of Chapter 5.4 do not apply to excepted packages of radioactive material, except that the UN number preceded by the letters "UN" and the name and address of the consignor and the consignee shall be shown on a transport document such as a bill of lading, air waybill or CMR or CIM consignment note.

5.1.5.5 Summary of approval and prior notification requirements

- NOTE 1:** Before first shipment of any package requiring competent authority approval of the design, the consignor shall ensure that a copy of the approval certificate for that design has been submitted to the competent authority of each country en route (see 5.1.5.1.4 (a)).
- 2:** Notification required if contents exceed $3 \times 10^3 A_1$, or $3 \times 10^3 A_2$, or 1000 TBq; (see 5.1.5.1.4 (b)).
- 3:** Multilateral approval of shipment required if contents exceed $3 \times 10^3 A_1$, or $3 \times 10^3 A_2$, or 1000 TBq, or if controlled intermittent venting is allowed (see 5.1.5.1).
- 4:** See approval and prior notification provisions for the applicable package for carrying this material.

Subject	UN Number	Competent authority approval required		Consignor required to notify the competent authorities of the country of origin and of the countries en route ^(a) before each shipment	Reference
		Country of origin	Countries en route ^(a)		
Calculation of unlisted A_1 and A_2 values	–	Yes	Yes	No	–
Excepted packages – package design – shipment	2908, 2909, 2910, 2911	No No	No No	No No	–

Subject	UN Number	Competent authority approval required		Consignor required to notify the competent authorities of the country of origin and of the countries en route ^(a) before each shipment	Reference
		Country of origin	Countries en route ^(a)		
LSA material ^(b) and SCO ^(b) /Industrial packages types 1, 2 or 3, non fissile and fissile excepted – package design – shipment	2912, 2913, 3321, 3322	No No	No No	No No	–
Type A packages ^(b) , non fissile and fissile excepted – package design – shipment	2915, 3332	No No	No No	No No	–
Type B(U) packages ^(b) non fissile and fissile excepted – package design – shipment	2916	Yes No	No No	See Note 1 See Note 2	5.1.5.1.4 (b), 5.1.5.2.1 (a), 6.4.22.2
Type B(M) packages ^(b) , non fissile and fissile excepted – package design – shipment	2917	Yes See Note 3	Yes See Note 3	No Yes	5.1.5.1.4 (b), 5.1.5.2.1 (a), 5.1.5.1.2, 6.4.22.3
Type C packages ^(b) , non fissile and fissile excepted – package design – shipment	3323	Yes No	No No	See Note 1 See Note 2	5.1.5.1.4 (b), 5.1.5.2.1 (a), 6.4.22.2
Packages for fissile material – package design – shipment: sum of criticality safety indexes not more than 50 sum of criticality safety indexes greater than 50	2977, 3324, 3325, 3326, 3327, 3328, 3329, 3330, 3331, 3333	Yes ^(c) No ^(d) Yes	Yes ^(c) No ^(d) Yes	No See Note 2 See Note 2	5.1.5.2.1 (a), 5.1.5.1.2, 6.4.22.4
Special form radioactive material – design – shipment	– See Note 4	Yes See Note 4	No See Note 4	No See Note 4	1.6.6.3, 5.1.5.2.1 (a), 6.4.22.5
Low dispersable radioactive material – design – shipment	– See Note 4	Yes See Note 4	No See Note 4	No See Note 4	5.1.5.2.1 (a), 6.4.22.3
Packages containing 0.1 kg or more of uranium hexafluoride – design – shipment	– See Note 4	Yes See Note 4	No See Note 4	No See Note 4	5.1.5.2.1 (a), 6.4.22.1
Special Arrangement – shipment	2919, 3331	Yes	Yes	Yes	1.7.4.2, 5.1.5.2.1 (b), 5.1.5.1.4 (b)
Approved packages designs subjected to transitional measures		See 1.6.6	See 1.6.6	See Note 1	1.6.6.1, 1.6.6.2, 5.1.5.1.4 (b), 5.1.5.2.1 (a), 5.1.5.1.2

(a) Countries from, through or into which the consignment is carried.

(b) If the radioactive contents are fissile material which is not excepted from the provisions for packages containing fissile material, then the provisions for fissile material packages apply (see 6.4.11).

- (c) Designs of packages for fissile material may also require approval in respect of one of the other items in the table.
- (d) Shipments may, however, require approval in respect of one of the other items in the table.

Chapter 5.2

Marking and labelling

5.2.1 Marking of packages

NOTE: For markings related to the construction, testing and approval of packagings, large packagings, pressure receptacles and IBCs, see Part 6.

5.2.1.1 Unless provided otherwise in RID, the UN number corresponding to the dangerous goods contained, preceded by the letters "UN" shall be clearly and durably marked on each package. In the case of unpackaged articles the marking shall be displayed on the article, on its cradle or on its handling, storage or launching device.

5.2.1.2 All package markings required by this Chapter:

- (a) shall be readily visible and legible;
- (b) shall be able to withstand open weather exposure without a substantial reduction in effectiveness.

5.2.1.3 Salvage packagings shall additionally be marked with the word "SALVAGE".

5.2.1.4 Intermediate bulk containers of more than 450 litres capacity and large packagings shall be marked on two opposite sides.

5.2.1.5 Additional provisions for goods of Class 1

For goods of Class 1, packages shall, in addition, bear the proper shipping name as determined in accordance with 3.1.2. The marking, which shall be clearly legible and indelible, shall be in an official language of the country of origin and also, if that language is not French, German, Italian or English, in French, German, Italian or English unless any agreements concluded between the countries concerned in the transport operation provide otherwise.

For military consignments within the meaning of 1.5.2 carried as a full wagon load or as a closed load, packages may be marked with the descriptions prescribed by the competent military authority instead of the proper shipping name.

5.2.1.6 Additional provisions for goods of Class 2

Refillable receptacles shall bear the following particulars in clearly legible and durable characters:

(a) the UN number and the proper shipping name of the gas or mixture of gases, as determined in accordance with 3.1.2.

In the case of gases classified under an N.O.S. entry, only the technical name¹ of the gas has to be indicated in addition to the UN number.

In the case of mixtures, not more than the two constituents which most predominantly contribute to the hazards have to be indicated;

(b) for compressed gases filled by mass and for liquefied gases, either the maximum filling mass and the tare of the receptacle with fittings and accessories as fitted at the time of filling, or the gross mass;

(c) the date (year) of the next periodic inspection.

These marks can either be engraved or indicated on a durable information disk or label attached on the receptacle or indicated by an adherent and clearly visible marking such as by printing or by any equivalent process.

NOTE 1: See also 6.2.2.7.

2: For non refillable receptacles, see 6.2.2.8.

¹ Instead of the technical name the use of one of the following names is permitted:

- For UN No. 1078 refrigerant gas, n.o.s.: mixture F1, mixture F2, mixture F3;
- For UN No. 1060 methylacetylene and propadiene mixtures, stabilized: mixture P1, mixture P2;
- For UN No. 1965 hydrocarbon gas mixture, liquefied, n.o.s.: mixture A or butane, mixture A01 or butane, mixture A02 or butane, mixture A0 or butane, mixture A1, mixture B1, mixture B2, mixture B, mixture C or propane;
- For UN No. 1010 Butadienes, stabilized: 1,2-Butadiene, stabilized, 1,3-Butadiene, stabilized.

5.2.1.7 Special marking provisions for goods of Class 7

- 5.2.1.7.1 Each package shall be legibly and durably marked on the outside of the packaging with an identification of either the consignor or consignee, or both.
- 5.2.1.7.2 For each package, other than excepted packages, the UN number preceded by the letters "UN" and the proper shipping name shall be legibly and durably marked on the outside of the packaging. **The marking of excepted packages shall be as required by 5.1.5.4.1.**
- 5.2.1.7.3 Each package of gross mass exceeding 50 kg shall have its permissible gross mass legibly and durably marked on the outside of the packaging.
- 5.2.1.7.4 Each package which conforms to:
- (a) a Type IP-1 package, a Type IP-2 package or a Type IP-3 package design shall be legibly and durably marked on the outside of the packaging with "TYPE IP-1", "TYPE IP-2" or "TYPE IP-3" as appropriate;
 - (b) a Type A package design shall be legibly and durably marked on the outside of the packaging with "TYPE A";
 - (c) a Type IP-2 package, a Type IP-3 package or a Type A package design shall be legibly and durably marked on the outside of the packaging with the international vehicle registration code (VRI Code)² of the country of origin of design and either the name of the manufacturer or other identification of the packaging specified by the competent authority of the country of origin of design.
- 5.2.1.7.5 Each package which conforms to a design approved by the competent authority shall be legibly and durably marked on the outside of the packaging with:
- (a) the identification mark allocated to that design by the competent authority;
 - (b) a serial number to uniquely identify each packaging which conforms to that design;
 - (c) in the case of a Type B(U) or Type B(M) package design, with "TYPE B(U)" or "TYPE B(M)"; and
 - (d) in the case of a Type C package design, with "TYPE C".
- 5.2.1.7.6 Each package which conforms to a Type B(U), Type B(M) or Type C package design shall have the outside of the outermost receptacle which is resistant to the effects of fire and water plainly marked by embossing, stamping or other means resistant to the effects of fire and water with the trefoil symbol shown in the figure below.

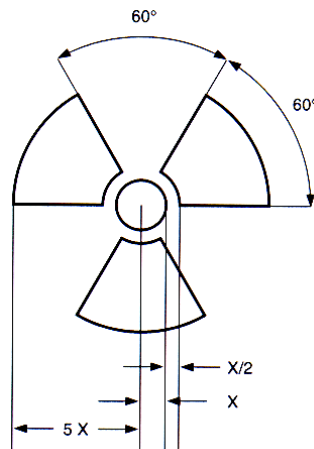

Basic trefoil symbol with proportions based on a central circle of radius X. The minimum allowable size of X shall be 4 mm.

- 5.2.1.7.7 Where LSA-I or SCO-I material is contained in receptacles or wrapping materials and is carried under exclusive use as permitted by 4.1.9.2.3, the outer surface of these receptacles or wrapping materials may bear the marking "RADIOACTIVE LSA-I" or "RADIOACTIVE SCO-I", as appropriate.
- 5.2.1.7.8 In **all cases of** international carriage of packages requiring competent authority design or shipment approval, for which different approval types apply in the different countries concerned **by the shipment**, marking shall be in accordance with the certificate of the country of origin of the design.

² Distinguishing sign for motor vehicles in international traffic prescribed in the Vienna Convention on Road Traffic (1968).

5.2.1.8 Special marking provisions for environmentally hazardous substances

5.2.1.8.1 Packages containing environmentally hazardous substances meeting the criteria of 2.2.9.1.10 shall be durably marked with the environmentally hazardous substance mark shown in 5.2.1.8.3 with the exception of single packagings and combination packagings where such single packagings or inner packagings of such combination packagings have:

- a quantity of 5 l or less for liquids; or
- a net mass of 5 kg or less for solids.

5.2.1.8.2 The environmentally hazardous substance mark shall be located adjacent to the markings required by 5.2.1.1. The requirements of 5.2.1.2 and 5.2.1.4 shall be met.

5.2.1.8.3 The environmentally hazardous substance mark shall be as shown below. The dimensions shall be 100 mm × 100 mm, except in the case of packages of such dimensions that they can only bear smaller marks.



Symbol (fish and tree): black on white or suitable contrasting background

5.2.1.9 Orientation arrows

5.2.1.9.1 Except as provided in 5.2.1.9.2:

- combination packagings having inner packagings containing liquids;
- single packagings fitted with vents; and
- cryogenic receptacles intended for the carriage of refrigerated liquefied gases,

shall be legibly marked with package orientation arrows which are similar to the illustration shown below or with those meeting the specifications of ISO 780:1997. The orientation arrows shall appear on two opposite vertical sides of the package with the arrows pointing in the correct upright direction. They shall be rectangular and of a size that is clearly visible commensurate with the size of the package. Depicting a rectangular border around the arrows is optional.

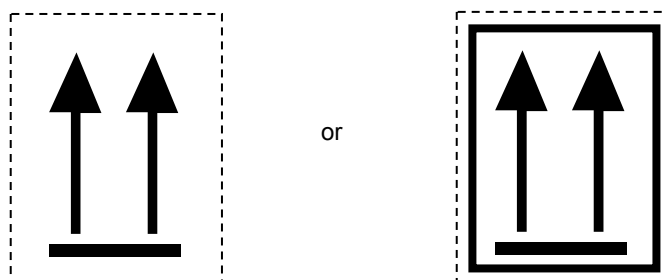

Two black or red arrows on white or suitable contrasting background. The rectangular border is optional.

5.2.1.9.2 Orientation arrows are not required on packages containing:

- pressure receptacles except for cryogenic receptacles;
- dangerous goods in inner packagings of not more than 120 ml which are prepared with sufficient absorbent material between the inner and outer packagings to completely absorb the liquid contents;
- Class 6.2 infectious substances in primary receptacles of not more than 50 ml;
- Class 7 radioactive material in Type IP-2, Type IP-3, Type A, Type B(U), Type B(M) or Type C packages;
- articles which are leak-tight in all orientations (e.g. alcohol or mercury in thermometers, aerosols, etc.);

(f) Combination packagings containing hermetically sealed inner packagings each containing not more than 500 ml.

5.2.1.9.3 Arrows for purposes other than indicating proper package orientation shall not be displayed on a package marked in accordance with this sub-section.

5.2.2 Labelling of packages

NOTE: For labelling purposes, small containers shall be considered as packages.

5.2.2.1 Labelling provisions

5.2.2.1.1 For each article or substance listed in Table A of Chapter 3.2, the labels shown in Column (5) shall be affixed unless otherwise provided for by a special provision in Column (6).

5.2.2.1.2 Indelebile danger markings corresponding exactly to the prescribed models may be used instead of labels.

**5.2.2.1.3 -
5.2.2.1.5** (Reserved)

5.2.2.1.6 Except as provided in 5.2.2.2.1.2, each label shall:

- (a) be affixed to the same surface of the package, if the dimensions of the package allow; for packages of Class 1 and 7, near the mark indicating the proper shipping name;
- (b) be so placed on the package that it is not covered or obscured by any part or attachment to the packaging or any other label or marking; and
- (c) be displayed next to each other when more than one label is required.

Where a package is of such an irregular shape or small size that a label cannot be satisfactorily affixed, the label may be attached to the package by a securely affixed tag or other suitable means.

5.2.2.1.7 Intermediate bulk containers of more than 450 litres capacity and large packagings shall be labelled on two opposite sides.

5.2.2.1.8 Special requirements for the labelling of packages containing explosive substances or articles when carried as a military consignment

For the carriage of military consignments within the meaning of 1.5.2, as a full wagon load or wagon load it shall not be necessary for packages to bear the danger labels prescribed in column (5) of Table A of Chapter 3.2, provided that the mixed loading requirements prescribed in 7.5.2 are observed on the basis of the information in the transport document, in accordance with 5.4.1.2.1 (f).

5.2.2.1.9 Special provisions for the labelling of self-reactive substances and organic peroxides

- (a) The label conforming to model No. 4.1 also implies that the product may be flammable and hence no label conforming to model No. 3 is required. In addition, a label conforming to model No. 1 shall be applied for self-reactive substances Type B, unless the competent authority has permitted this label to be dispensed with for a specific packaging because test data have proven that the self-reactive substance in such a packaging does not exhibit explosive behaviour.
- (b) The label conforming to model No. 5.2 also implies that the product may be flammable and hence no label conforming to model No. 3 is required. In addition, the following labels shall be applied:
 - (i) A label conforming to model No. 1 for organic peroxides type B, unless the competent authority has permitted this label to be dispensed with for a specific packaging because test data have proven that the organic peroxide in such a packaging does not exhibit explosive behaviour;
 - (ii) A label conforming to model No. 8 is required when Packing Group I or II criteria of Class 8 are met.

For self-reactive substances and organic peroxides mentioned by name, the labels to be affixed are indicated in the list found in 2.2.41.4 and 2.2.52.4 respectively.

5.2.2.1.10 Special provisions for the labelling of infectious substances packages

In addition to the label conforming to model No. 6.2, infectious substances packages shall bear any other label required by the nature of the contents.

5.2.2.1.11 Special provisions for the labelling of radioactive material

5.2.2.1.11.1 Except when enlarged labels are used in accordance with 5.3.1.1.3, each package, overpack and container containing radioactive material shall bear at least two labels which conform to the models Nos. 7A, 7B, and 7C as appropriate according to the category (see 5.1.5.3.4) of that package, overpack or container. Labels shall be affixed to two opposite sides on the outside of the package or on the outside of all four sides of the container. Each overpack containing radioactive material shall bear at least two labels on opposite sides of the outside of the overpack. In addition, each package, overpack and container containing fissile material, other than fissile material excepted under 6.4.11.2 shall bear labels which conform to model No. 7E; such

labels, where applicable shall be affixed adjacent to the labels for radioactive material. Labels shall not cover the markings specified in 5.2.1. Any labels which do not relate to the contents shall be removed or covered.

5.2.2.1.11.2 Each label conforming to models Nos.7A, 7B, and 7C shall be completed with the following information.

(a) Contents:

- (i) except for LSA-I material, the name(s) of the radionuclide(s) as taken from Table 2.2.7.2.2.1, using the symbols prescribed therein. For mixtures of radionuclides, the most restrictive nuclides shall be listed to the extent the space on the line permits. The group of LSA or SCO shall be shown following the name(s) of the radionuclide(s). The terms "LSA-II", "LSA-III", "SCO-I" and "SCO-II" shall be used for this purpose;
- (ii) for LSA-I material, only the term "LSA-I" is necessary; the name of the radionuclide is not necessary;

(b) Activity:

The maximum activity of the radioactive contents during carriage expressed in becquerels (Bq) with the appropriate SI prefix symbol (see 1.2.2.1). For fissile material, the mass of fissile material **(or mass of each fissile nuclide for mixtures when appropriate)** in grams (g), or multiples thereof, may be used in place of activity;

- (c) For overpacks and containers the "contents" and "activity" entries on the label shall bear the information required in (a) and (b) above, respectively, totalled together for the entire contents of the overpack or container except that on labels for overpacks or containers containing mixed loads of packages containing different radionuclides, such entries may read "See transport documents";
- (d) Transport index: The number determined in accordance with 5.1.5.3.1 and 5.1.5.3.2 (no transport index entry is required for category I-WHITE).

5.2.2.1.11.3 Each label conforming to the model No. 7E shall be completed with the criticality safety index (CSI) as stated in the certificate of approval for special arrangement or the certificate of approval for the package design issued by the competent authority.

5.2.2.1.11.4 For overpacks and containers, the criticality safety index (CSI) on the label shall bear the information required in 5.2.2.1.11.3 totalled together for the fissile contents of the overpack or container.

5.2.2.1.11.5 In **all cases** of international carriage of packages requiring competent authority design or shipment approval, for which different approval types apply in the different countries concerned **by the shipment**, labelling shall be in accordance with the certificate of the country of origin of design.

5.2.2.2 Provisions for labels

5.2.2.2.1 Labels shall satisfy the provisions below and conform, in terms of colour, symbols and general format, to the models shown in 5.2.2.2.2. Corresponding models required for other modes of transport, with minor variations which do not affect the obvious meaning of the label, are also acceptable.

NOTE: Where appropriate, labels in 5.2.2.2.2 are shown with a dotted outer boundary as provided for in 5.2.2.2.1.1. This is not required when the label is applied on a background of contrasting colour.

5.2.2.2.1.1 Labels shall be in the form of a square set at an angle of 45° (diamond-shaped) with minimum dimensions of 100 mm by 100 mm. They shall have a line 5 mm inside the edge and running parallel with it. In the upper half of a label the line shall have the same colour as the symbol and in the lower half it shall have the same colour as the figure in the bottom corner. Labels shall be displayed on a background of contrasting colour, or shall have either a dotted or solid outer boundary line. If the size of the package so requires, the dimensions of the labels may be reduced, provided that they remain clearly visible.

5.2.2.2.1.2 Cylinders for Class 2 may, on account of their shape, orientation and securing mechanisms for carriage, bear labels representative of those specified in this section, which have been reduced in size, according to the dimensions outlined in ISO 7225:2005, "Gas cylinders – Precautionary labels", for display on the non-cylindrical part (shoulder) of such cylinders.

Notwithstanding the provisions of 5.2.2.1.6, labels may overlap to the extent provided for by ISO 7225:2005. However, in all cases, the primary risk label and the figures appearing on any label shall remain fully visible and the symbols recognizable.

Empty uncleaned pressure receptacles for gases of Class 2 may be carried with obsolete or damaged labels for the purposes of refilling or inspection as appropriate and the application of a new label in conformity with current regulations or for the disposal of the pressure receptacle.

5.2.2.2.1.3 With the exception of labels for Divisions 1.4, 1.5 and 1.6 of Class 1, the upper half of the label shall contain the pictorial symbol and the lower half shall contain:

- (a) For Classes 1, 2, 3, 5.1, 5.2, 7, 8 and 9, the class number;
- (b) For Classes 4.1, 4.2 and 4.3, the figure "4";

(c) For Classes 6.1 and 6.2, the figure "6".

The labels may include text such as the UN number or words describing the hazard (e.g. "flammable") in accordance with 5.2.2.2.1.5 provided the text does not obscure or detract from the other required label elements.

- 5.2.2.2.1.4** In addition, except for Divisions 1.4, 1.5 and 1.6, labels for Class 1 shall show in the lower half, above the class number, the division number and the compatibility group letter for the substance or article. Labels for Divisions 1.4, 1.5 and 1.6 shall show in the upper half the division number, and in the lower half the class number and the compatibility group letter.
- 5.2.2.2.1.5** On labels other than those for material of Class 7, the optional insertion of any text (other than the class number) in the space below the symbol shall be confined to particulars indicating the nature of the risk and precautions to be taken in handling.
- 5.2.2.2.1.6** The symbols, text and numbers shall be clearly legible and indelible and shall be shown in black on all labels except for:
- (a) the Class 8 label, where the text (if any) and class number shall appear in white;
 - (b) labels with entirely green, red or blue backgrounds where they may be shown in white;
 - (c) the Class 5.2 label, where the symbol may be shown in white; and
 - (d) labels conforming to model No. 2.1 displayed on cylinders and gas cartridges for gases UN Nos. 1011, 1075, 1965 and 1978, where they may be shown in the background colour of the receptacle if adequate contrast is provided.
- 5.2.2.2.1.7** All labels shall be able to withstand open weather exposure without a substantial reduction in effectiveness.

5.2.2.2.2 Specimen labels

Class 1 hazard
Explosive substances or articles



(No. 1)
Divisions 1.1, 1.2 and 1.3
Symbol (exploding bomb): black;
Background: orange; Figure "1" in
bottom corner



(No. 1.4)
Division 1.4



(No. 1.5)
Division 1.5



(No. 1.6)
Division 1.6

Background: orange; Figures: black; Numerals shall be about 30 mm in height and be about 5 mm thick (for a label measuring 100 mm x 100 mm); Figure "1" in bottom corner

** Place for division – to be left blank if explosive is the subsidiary risk

* Place for compatibility group – to be left blank if explosive is the subsidiary risk

Class 2 hazard
Gases



(No. 2.1)
Flammable gases

Symbol (flame): black or white (except as provided for in 5.2.2.2.1.6 (d)); Background:red; Figure "2" in bottom corner



(No. 2.2)
Non flammable, non-toxic gases

Symbol (gas cylinder): black or white;
Background: green; Figure "2" in bottom corner





(No. 2.3)
Toxic gases
Symbol (skull and crossbones): black;

Background: white; Figure "2" in bottom corner

**Class 3 hazard
Flammable liquids**



(No. 3)
Symbol (flame): black or white; Background: red; Figure "3" in bottom corner

**Class 4.1 hazard
Flammable solids, self-reactive substances and solid desensitized explosives**



(No. 4.1)
Symbol (flame): black;
Background: white with seven vertical red stripes; Figure "4" in bottom corner

**Class 4.2 hazard
Substances liable to spontaneous combustion**



(No. 4.2)
Symbol (flame): black;
Background: upper half white, lower half red; Figure "4" in bottom corner

**Class 4.3 hazard
Substances which, in contact with water, emit flammable gases**



(No. 4.3)
Symbol (flame): black or white; Background: blue; Figure "4" in bottom corner

**Class 5.1 hazard
Oxidizing substances**



(Nr. 5.1)
Symbol (flame over circle): black;
Background: yellow;
Figure "5.1" in bottom corner

**Class 5.2 hazard
Organic peroxides**



(Nr. 5.2)
Symbol (flame): black or white; Background: upper half red; lower half yellow;
Figure "5.2" in bottom corner

**Class 6.1 hazard
Toxic substances**



(No. 6.1)

Symbol (skull and crossbones): black;
Background: white; Figure "6" in bottom corner

**Class 6.2 hazard
Infectious substances**



(No. 6.2)

The lower half of the label may bear the inscriptions:
"INFECTIOUS SUBSTANCE" and "IN THE CASE OF DAMAGE OR LEAKAGE IMMEDIATELY NOTIFY PUBLIC HEALTH AUTHORITY"; Symbol (three crescents superimposed on a circle) and inscriptions: black; Background: white; Figure "6" in bottom corner

**Class 7 hazard
Radioactive material**



(No. 7A)

Category I – WHITE
Symbol (trefoil): black; Background: white; Text (mandatory): black in lower half of label:
"RADIOACTIVE"
"CONTENTS ..."
"ACTIVITY ...";
One red bar shall follow the word "RADIOACTIVE"; Figure "7" in bottom corner



(No. 7B)

Category II - YELLOW
Symbol (trefoil): black; Background: upper half yellow with white border, lower half white; Text (mandatory): black in lower half of label:
"RADIOACTIVE"
"CONTENTS ..."
"ACTIVITY ...";
In a black outlined box: "TRANSPORT INDEX"
Two red vertical bars shall follow the word "RADIOACTIVE"; Figure "7" in bottom corner



(No. 7C)

Category III – YELLOW
Symbol (trefoil): black; Background: upper half yellow with white border, lower half white; Text (mandatory): black in lower half of label:
"RADIOACTIVE"
"CONTENTS ..."
"ACTIVITY ...";
In a black outlined box: "TRANSPORT INDEX"
Three red vertical bars shall follow the word "RADIOACTIVE"; Figure "7" in bottom corner

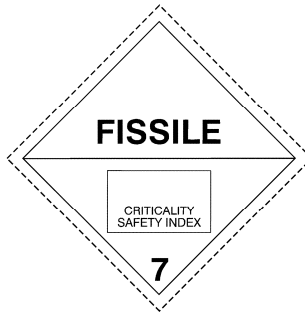

(No. 7E)

Class 7 fissile material

Background: white; Text (mandatory): black in upper half of label: "FISSILE";

In a black outlined box in the lower half of the label: "CRITICALITY SAFETY INDEX"; Figure "7" in bottom corner

Class 8 hazard
Corrosive substances

Class 9 hazard
Miscellaneous dangerous substances and articles



(No. 8)

Symbol (liquids, spilling from two glass vessels and attacking a hand and a metal): black; Background: upper half white; lower half black with white border; Figure "8" in bottom corner

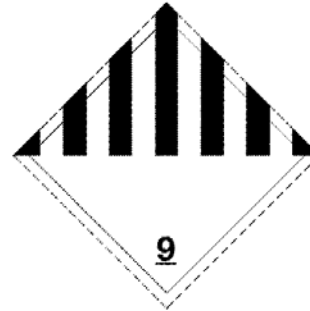

(No. 9)

Symbol (seven vertical stripes in upper half): black; Background: white; Figure "9" underlined in bottom corner

Chapter 5.3

Placarding and marking

NOTE: For placarding and marking of containers, MEGCs, tank-containers and portable tanks for carriage in a transport chain including a maritime journey, see also 1.1.4.2.1.

5.3.1 Placarding

5.3.1.1 General provisions

5.3.1.1.1 As and when required in this section, placards shall be affixed to the exterior surface of large containers, MEGCs, tank-containers, portable tanks and wagons. Placards shall correspond to the labels required in Column (5) and, where appropriate, Column (6) of Table A of Chapter 3.2 for the dangerous goods contained in the large container, MEGC, tank-container, portable tank or wagon and shall conform to the specifications given in 5.3.1.7. Placards shall be displayed on a background of contrasting colour, or shall have either a dotted or solid outer boundary line.

NOTE: For shunting model labels Nos. 13 and 15, see 5.3.4.

5.3.1.1.2 For Class 1, compatibility groups shall not be indicated on placards if the wagon or large container is carrying substances or articles belonging to two or more compatibility groups. Wagons or large containers carrying substances or articles of different divisions shall bear only placards conforming to the model of the most dangerous division in the order:

1.1 (most dangerous), 1.5, 1.2, 1.3, 1.6, 1.4 (least dangerous).

When 1.5 D substances are carried with substances or articles of Division 1.2, the wagon or large container shall be placarded as Division 1.1.

Placards are not required for the carriage of explosives of Division 1.4, compatibility group S.

Wagons and large containers in which packages are loaded to be carried as military consignments, within the meaning of 1.5.2, and which in conformity with 5.2.2.1.8 do not bear danger labels, shall, in the case of wagons, bear on both sides and, in the case of large containers, bear on all four sides, the placards in accordance with column (5) of Table A of Chapter 3.2.

5.3.1.1.3 For Class 7, the primary risk placard shall conform to model No. 7D as specified in 5.3.1.7.2. This placard is not required for wagons or large containers carrying excepted packages.

Where both Class 7 labels and placards would be required to be affixed to wagons, large containers, MEGCs, tank-containers or portable tanks, an enlarged label corresponding to the label required may be displayed instead of placard No.7D to serve both purposes.

5.3.1.1.4 Large containers, MEGCs, tank-containers, portable tanks or wagons containing goods of more than one class need not bear a subsidiary risk placard if the hazard represented by that placard is already indicated by a primary or subsidiary risk placard.

5.3.1.1.5 Placards which do not relate to the dangerous goods being carried, or residues thereof, shall be removed or covered.

5.3.1.1.6 When the placarding is affixed to folding panels, they shall be designed and secured so that they cannot unfold or come loose from the holder during carriage (especially as a result of impacts or unintentional actions).

5.3.1.2 Placarding of large containers, MEGCs, tank-containers and portable tanks

The placards shall be affixed to both sides and at each end of the large container, MEGC, tank-container or portable tank.

When the tank-container or portable tank has multiple compartments and carries two or more dangerous goods, the appropriate placards shall be displayed along each side at the position of the relevant compartments and one placard of each model shown on each side at both ends.

5.3.1.3 Placarding of wagons carrying large containers, MEGCs, tank-containers or portable tanks

NOTE: For the placarding of carrying wagons used in piggyback transport, see 1.1.4.4.

If the placards affixed to the large containers, MEGCs, tank-containers or portable tanks are not visible from outside the carrying wagons, the same placards shall also be affixed to both sides of the wagon. Otherwise, no placard need be affixed on the carrying wagon.

5.3.1.4 Placarding of wagons for carriage in bulk, tank-wagons, battery-wagons and wagons with demountable tanks

Placards shall be affixed to both sides.

When the tank-wagon or the demountable tank carried on the wagon has multiple compartments and carries two or more dangerous goods, the appropriate placards shall be displayed along each side at the position of the relevant compartments. However, in such case, if all compartments have to bear the same placards, these placards need be displayed only once along each side.

Where more than one placard is required for the same compartment, these placards shall be displayed adjacent to each other.

5.3.1.5 Placarding of wagons carrying packages only

Placards shall be affixed to both sides.

5.3.1.6 Placarding of empty tank-wagons, battery-wagons, MEGCs, tank-containers, portable tanks and empty wagons and large containers for carriage in bulk

Empty tank-wagons, wagons with demountable tanks, battery-wagons, MEGCs, tank-containers and portable tanks uncleaned and not degassed or decontaminated, and empty wagons and large containers for carriage in bulk, uncleaned or not decontaminated, shall continue to display the placards required for the previous load.

5.3.1.7 Specifications for placards

5.3.1.7.1 Except as provided in 5.3.1.7.2 for the Class 7 placard, a placard shall:

- (a) Be not less than 250 mm by 250 mm and have a line 12.5 mm inside the edge and running parallel with it. In the upper half the line shall have the same colour as the symbol and in the lower half it shall have the same colour as the figure in the bottom corner;
- (b) Correspond to the label required for the dangerous goods in question with respect to colour and symbol (see 5.2.2.2); and
- (c) Display the numbers (and for goods of Class 1, the compatibility group letter) prescribed for the dangerous goods in question in 5.2.2.2 for the corresponding label, in digits not less than 25 mm high.

The requirements of 5.2.2.1.2 shall also apply.

5.3.1.7.2 The Class 7 placard shall be not less than 250 mm by 250 mm with a black line running 5 mm inside the edge and parallel with it and is otherwise as shown below (Model No. 7D). The number "7" shall not be less than 25 mm high. The background colour of the upper half of the placard shall be yellow and of the lower half white, the colour of the trefoil and the printing shall be black. The use of the word "RADIOACTIVE" in the bottom half is optional to allow the use of this placard to display the appropriate UN number for the consignment.

Placard for radioactive material of Class 7

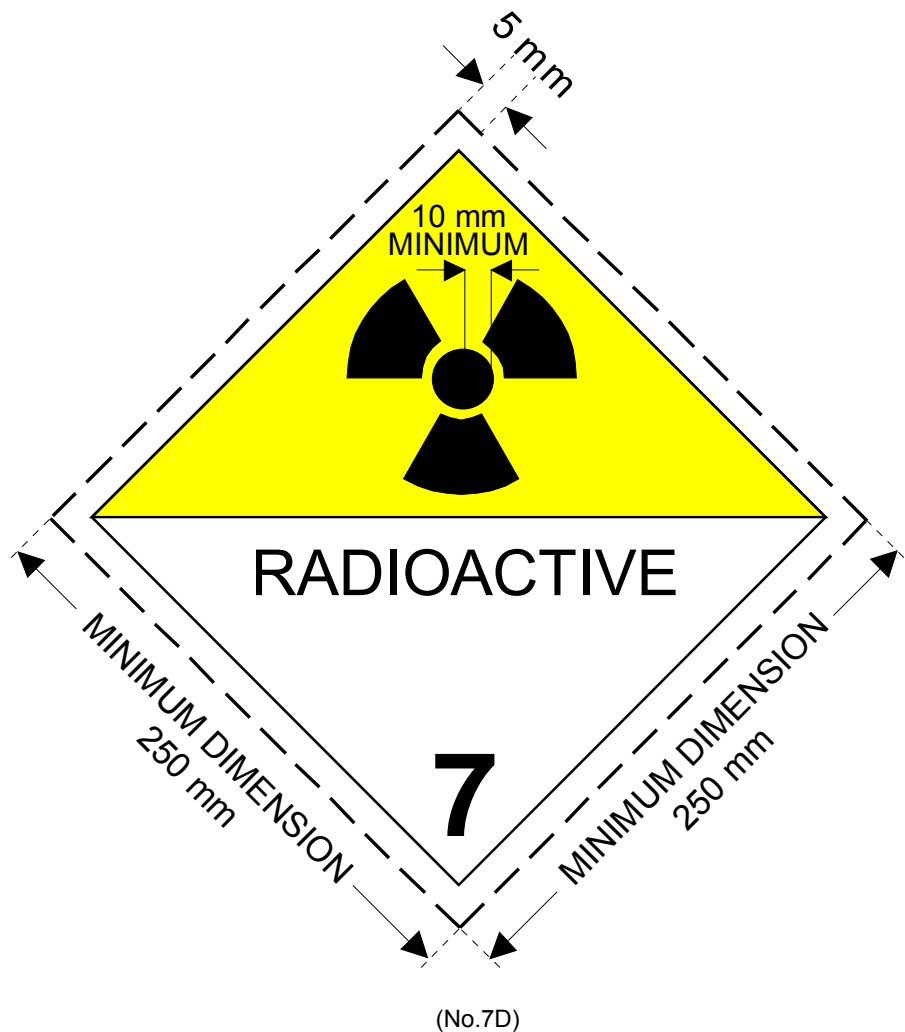

Symbol (trefoil): black; Background: upper half yellow with white border, lower half white;

The lower half shall show the word "RADIOACTIVE" or alternatively, when required, the appropriate UN Number (see 5.3.2.1.2) and the figure "7" in the bottom corner.

- 5.3.1.7.3** For tank-containers with a capacity of not more than 3 m³, placards may be replaced by labels conforming to 5.2.2.2.
- 5.3.1.7.4** The dimensions of the placards to be affixed to wagons may be reduced to 150 mm x 150 mm. In this case, the other dimensions prescribed for the symbols, lines, figures and letters do not apply.
- 5.3.2 Orange-coloured plate marking**
- 5.3.2.1 General orange-coloured plate marking provisions**
- NOTE:** For the orange-coloured marking of carrying wagons used in piggyback transport, see 1.1.4.4.
- 5.3.2.1.1** A rectangular, orange-coloured plate conforming to 5.3.2.2.1, and so as to be clearly visible, shall be affixed on each side of a
- tank-wagon,
 - battery-wagon,
 - wagon with demountable tanks,
 - tank-container,
 - MEGC,
 - portable tank,
 - wagon for carriage in bulk,
 - small or large container for carriage in bulk,

- wagons and containers carrying packaged radioactive material with a single UN number under exclusive use and no other dangerous goods

used for the carriage of goods for which a hazard identification number is given in column (20) of Table A of Chapter 3.2.

This plate may also be affixed on both sides of wagon loads made up of packages containing one and the same substance.

- 5.3.2.1.2** These orange-coloured plates shall bear the hazard identification number and the UN number, in accordance with 5.3.2.2.2, prescribed respectively in columns (20) and (1) of Table A of Chapter 3.2 for the substance carried.

When a number of different substances are carried in a tank-wagon, battery-wagon, wagon with demountable tank, tank-container, MEGC or portable tank in separate tanks or separate compartments of the same tank, the consignor shall affix the orange-coloured plate as required in 5.3.2.1.1, bearing the appropriate numbers, on each side of the tanks or tank compartments, parallel to the longitudinal axis of the wagon, tank-container or portable tank and so as to be clearly visible.

- 5.3.2.1.3** (Reserved)

- 5.3.2.1.4** (Reserved)

- 5.3.2.1.5** If the orange-coloured plates prescribed in 5.3.2.1.1 affixed to the containers, tank-containers, MEGCs or portable tanks are not clearly visible from outside the carrying wagon, the same plates shall also be affixed to both sides of the wagon.

NOTE: This paragraph need not be applied to the marking with orange coloured plates of closed and sheeted wagons, carrying tanks with a maximum capacity of 3 000 litres.

- 5.3.2.1.6** (Deleted)

- 5.3.2.1.7** The requirements of 5.3.2.1.1 to 5.3.2.1.5 are also applicable to empty

- tank-wagons,
- battery-wagons,
- wagons with demountable tanks,
- tank-containers,
- portable tanks and
- MEGCs,

uncleaned, not degassed or not decontaminated,

as well as to empty wagons, large containers and small containers for carriage in bulk, uncleaned or not decontaminated.

- 5.3.2.1.8** Orange-coloured plates which do not relate to dangerous goods carried, or residues thereof, shall be removed or covered. If plates are covered, the covering shall be total and remain effective after 15 minutes' engulfment in fire.

5.3.2.2 Specifications for the orange-coloured plates

- 5.3.2.2.1** The orange-coloured plates may be reflectorized and shall be of 40 cm base and of 30 cm high; they shall have a black border of 15 mm wide. The material used shall be weather-resistant and ensure durable marking. The plate shall not become detached from its mount in the event of 15 minutes' engulfment in fire. It shall remain affixed irrespective of the orientation of the wagon.

The plates prescribed in 5.3.2.1.2 and 5.3.2.1.5 may be replaced by a self-adhesive sheet, by paint or by any other equivalent process. This alternative marking shall conform to the specifications set in this subsection except for the provisions concerning resistance to fire mentioned in 5.3.2.2.1 and 5.3.2.2.2.

NOTE: The colour of the orange plates in conditions of normal use should have chromaticity co-ordinates lying within the area on the chromaticity diagram formed by joining the following co-ordinates

Chromaticity co-ordinates of points at the corners of the area on the chromaticity diagram				
x	0,52	0,52	0,578	0,618
y	0,38	0,40	0,422	0,38

Luminance factor of non-reflectorized colour: $\beta \geq 0.22$, of reflectorized colour: $\beta > 0.12$.

Reference centre E, standard illuminant C, normal incidence 45°, viewed at 0°.

Co-efficient of reflex luminous intensity at an angle of illumination of 5°, viewed at 0.2°: not less than 20 candelas per lux per m².

5.3.2.2.2 The hazard identification number and the UN number shall consist of black digits 100 mm high and of 15 mm stroke thickness. The hazard-identification number shall be inscribed in the upper part of the plate and the UN number in the lower part; they shall be separated by a horizontal black line, 15 mm in stroke width, extending from side to side of the plate at mid-height (see 5.3.2.2.3).

The hazard identification number and the UN number shall be indelible and shall remain legible after 15 minutes' engulfment in fire.

Interchangeable numbers and letters on plates presenting the hazard identification number and the UN number shall remain in place during carriage and irrespective of the orientation of the wagon.

5.3.2.2.3 Example of orange-coloured plate with hazard identification number and UN number

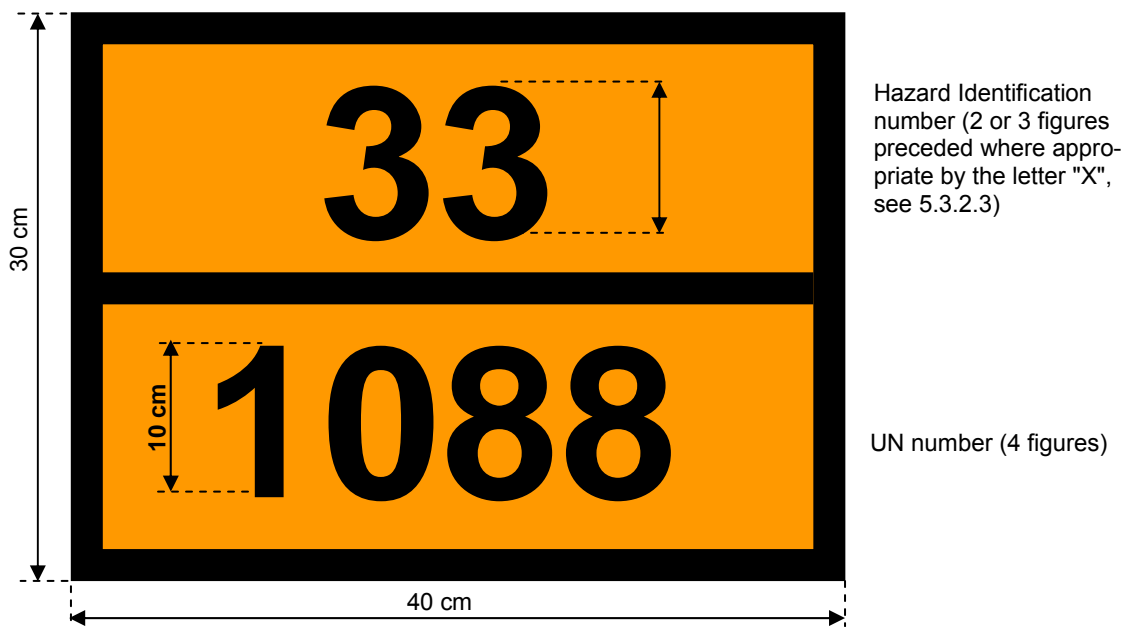

Background orange.

Border, horizontal line and figures black, 15 mm thickness.

5.3.2.2.4 The permitted tolerances for dimensions specified in this sub-section are $\pm 10\%$.

5.3.2.2.5 When the orange-coloured plate or the alternative marking referred to in 5.3.2.2.1 is affixed to folding panels, they shall be designed and secured so that they cannot unfold or come loose from the holder during carriage (especially as a result of impacts or unintentional actions).

5.3.2.3 Meaning of hazard identification numbers

5.3.2.3.1 For substances of classes 2 to 9 the hazard identification number consists of two or three figures.

In general, the figures indicate the following hazards:

- 2 Emission of gas due to pressure or to chemical reaction
- 3 Flammability of liquids (vapours) and gases or self-heating liquid
- 4 Flammability of solids or self-heating solid
- 5 Oxidizing (fire-intensifying) effect
- 6 Toxicity or risk of infection
- 7 Radioactivity
- 8 Corrosivity
- 9 Risk of spontaneous violent reaction

NOTE: The risk of spontaneous violent reaction within the meaning of figure 9 include the possibility following from the nature of a substance of a risk of explosion, disintegration and polymerization reaction following the release of considerable heat or flammable and/or toxic gases.

Doubling of a figure indicates an intensification of that particular hazard.

Where the hazard associated with a substance can be adequately indicated by a single figure, this is followed by zero.

The following combinations of figures, however, have a special meaning: 22, 323, 333, 362, 382, 423, 44, 446, 462, 482, 539, 606, 623, 642, 823, 842, 90 and 99, see 5.3.2.3.2 below.

If a hazard identification number is prefixed by the letter "X", this indicates that the substance will react dangerously with water. For such substances, water may only be used by approval of experts.

For substances and articles of Class 1, the classification code in accordance with column (3b) of Table A of Chapter 3.2 shall be used as the hazard identification number. The classification code consists of:

- the division number in accordance with 2.2.1.1.5 and
- the compatibility group letter in accordance with 2.2.1.1.6.

5.3.2.3.2 The hazard identification numbers listed in Column (20) of table A of Chapter 3.2 have the following meanings:

20	Asphyxiant gas or gas with no subsidiary risk
22	Refrigerated liquefied gas, asphyxiant
223	Refrigerated liquefied gas, flammable
225	Refrigerated liquefied gas, oxidizing (fire-intensifying)
23	Flammable gas
238	Gas, flammable corrosive
239	Flammable gas, which can spontaneously lead to violent reaction
25	Oxidizing (fire-intensifying) gas
26	Toxic gas
263	Toxic gas, flammable
265	Toxic gas, oxidizing (fire-intensifying)
268	Toxic gas, corrosive
28	Gas, corrosive
285	Gas, corrosive, oxidizing
30	– Flammable liquid (flash-point between 23 °C and 60 °C, inclusive) or – Flammable liquid or solid in the molten state with a flash-point above 60 °C, heated to a temperature equal to or above its flash-point, or – Self-heating liquid
323	Flammable liquid which reacts with water, emitting flammable gases
X323	Flammable liquid which reacts dangerously with water, emitting flammable gases ³
33	Highly flammable liquid (flash-point below 23 °C)
333	Pyrophoric liquid
X333	Pyrophoric liquid which reacts dangerously with water ³
336	Highly flammable liquid, toxic
338	Highly flammable liquid, corrosive
X338	Highly flammable liquid, corrosive, which reacts dangerously with water ³
339	Highly flammable liquid which can spontaneously lead to violent reaction
36	Flammable liquid (flash-point between 23 °C and 60 °C, inclusive), slightly toxic, or self-heating liquid, toxic
362	Flammable liquid, toxic, which reacts with water, emitting flammable gases
X362	Flammable liquid toxic, which reacts dangerously with water, emitting flammable gases ³
368	Flammable liquid, toxic, corrosive
38	Flammable liquid (flash-point between 23 °C and 60 °C, inclusive), slightly corrosive or self-heating liquid, corrosive
382	Flammable liquid, corrosive, which reacts with water, emitting flammable gases
X382	Flammable liquid, corrosive, which reacts dangerously with water, emitting flammable gases ³
39	Flammable liquid, which can spontaneously lead to violent reaction
40	Flammable solid, or self-reactive substance, or self-heating substance
423	Solid which reacts with water, emitting flammable gases, or flammable solid which reacts with water, emitting flammable gases, or self-heating solid which reacts with water, emitting flammable gases
X423	Solid which reacts dangerously with water, emitting flammable gases ³ , or flammable solid which reacts dangerously with water, emitting flammable gases ³ , or self-heating solid which reacts dangerously with water, emitting flammable gases ³
43	Spontaneously flammable (pyrophoric) solid
X432	Spontaneously flammable (pyrophoric) solid which reacts dangerously with water, emitting flammable gases ³
44	Flammable solid, in the molten state at an elevated temperature
446	Flammable solid, toxic, in the molten state, at an elevated temperature
46	Flammable or self-heating solid, toxic
462	Toxic solid which reacts with water, emitting flammable gases

³ Water not to be used except by approval of experts.

X462	Solid which reacts dangerously with water, emitting toxic gases ³
48	Flammable or self-heating solid, corrosive
482	Corrosive solid which reacts with water, emitting flammable gases
X482	Solid which reacts dangerously with water, emitting corrosive gases ³
50	Oxidizing (fire-intensifying) substance
539	Flammable organic peroxide
55	Strongly oxidizing (fire-intensifying) substance
556	Strongly oxidizing (fire-intensifying) substance, toxic
558	Strongly oxidizing (fire-intensifying) substance, corrosive
559	Strongly oxidizing (fire-intensifying) substance, which can spontaneously lead to violent reaction
56	Oxidizing substance (fire-intensifying), toxic
568	Oxidizing substance (fire-intensifying), toxic, corrosive
58	Oxidizing substance (fire-intensifying), corrosive
59	Oxidizing substance (fire-intensifying) which can spontaneously lead to violent reaction
60	Toxic or slightly toxic substance
606	Infectious substance
623	Toxic liquid, which reacts with water, emitting flammable gases
63	Toxic substance, flammable (flash-point between 23 °C and 60 °C, inclusive)
638	Toxic substance, flammable (flash-point between 23 °C and 60 °C, inclusive), corrosive
639	Toxic substance, flammable (flash-point not above 60 °C) which can spontaneously lead to violent reaction
64	Toxic solid, flammable or self-heating
642	Toxic solid, which reacts with water, emitting flammable gases
65	Toxic substance, oxidizing (fire-intensifying)
66	Highly toxic substance
663	Highly toxic substance, flammable (flash-point not above 60 °C)
664	Highly toxic solid, flammable or self-heating
665	Highly toxic substance, oxidizing (fire-intensifying)
668	Highly toxic substance, corrosive
X668	highly toxic substance, corrosive, which reacts dangerously with water ³
669	Highly toxic substance which can spontaneously lead to violent reaction
68	Toxic substance, corrosive
69	Toxic or slightly toxic substance, which can spontaneously lead to violent reaction
70	Radioactive material
78	Radioactive material, corrosive
80	Corrosive or slightly corrosive substance
X80	Corrosive or slightly corrosive substance, which reacts dangerously with water ³
823	Corrosive liquid which reacts with water, emitting flammable gases
83	Corrosive or slightly corrosive substance, flammable (flash-point between 23 °C and 60 °C, inclusive)
X83	Corrosive or slightly corrosive substance, flammable (flash-point between 23 °C and 60 °C, inclusive), which reacts dangerously with water ³
839	Corrosive or slightly corrosive substance, flammable (flash-point between 23 °C and 60 °C inclusive) which can spontaneously lead to violent reaction
X839	Corrosive or slightly corrosive substance, flammable (flash-point between 23 °C and 60 °C inclusive), which can spontaneously lead to violent reaction and which reacts dangerously with water ³
84	Corrosive solid, flammable or self-heating
842	Corrosive solid which reacts with water, emitting flammable gases
85	Corrosive or slightly corrosive substance, oxidizing (fire-intensifying)
856	Corrosive or slightly corrosive substance, oxidizing (fire-intensifying) and toxic
86	Corrosive or slightly corrosive substance, toxic
88	Highly corrosive substance
X88	Highly corrosive substance, which reacts dangerously with water ³
883	Highly corrosive substance, flammable (flash-point between 23 °C and 60 °C inclusive)
884	Highly corrosive solid, flammable or self-heating
885	Highly corrosive substance, oxidizing (fire-intensifying)
886	Highly corrosive substance, toxic
X886	Highly corrosive substance, toxic, which reacts dangerously with water ³
89	Corrosive or slightly corrosive substance, which can spontaneously lead to violent reaction
90	Environmentally hazardous substance; miscellaneous dangerous substances
99	Miscellaneous dangerous substance carried at an elevated temperature.

5.3.3 Mark for elevated temperature substances

Tank-wagons, tank-containers, portable tanks, special wagons or large containers or especially equipped wagons or large containers for which a mark for elevated temperature substances is required according to special provision 580 in Column (6) of Table A of Chapter 3.2 shall bear on both sides for wagons, and on both sides and at each end for large containers, tank-containers and portable tanks, a triangular shaped mark with sides of at least 250 mm, to be shown in red, as reproduced below.



5.3.4 Shunting labels conforming to Models 13 and 15

5.3.4.1 General provisions

The general provisions of 5.3.1.1.1 and 5.3.1.1.5 and of 5.3.1.3 to 5.3.1.6 shall also apply to the shunting labels conforming to models Nos. 13 and 15.

Instead of the shunting labels, indelible marking corresponding exactly to the prescribed models may be affixed. This may simply consist of the red triangle with a black exclamation mark (at least 100 mm base by 70 mm height).

5.3.4.2 Description of shunting labels conforming to Models 13 and 15

The shunting labels conforming to Models 13 and 15 shall have the shape of a rectangle not smaller than A7 format (74 mm x 105 mm).

No. 13

Shunt with care

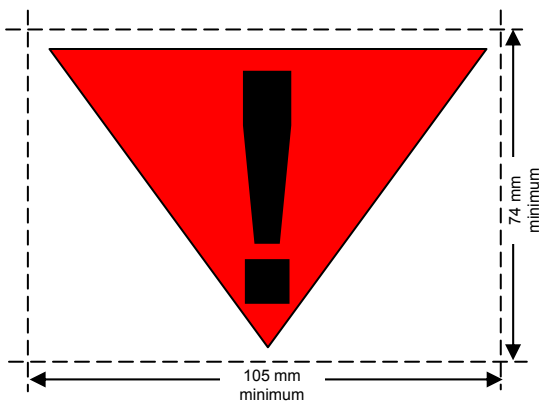

red triangle with an exclamation mark in black on white background

No. 15

Loose shunting or hump shunting forbidden. Shall be accompanied by a motive power unit. Shall not bump, or be bumped by, other wagons.

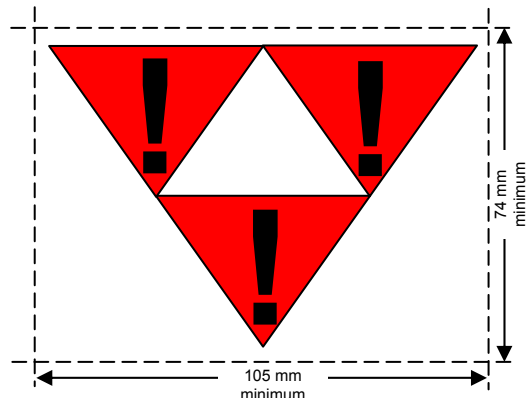

three triangles, red, with black exclamation mark

5.3.5 Orange band

Tank wagons intended for the carriage of liquefied, refrigerated liquefied or dissolved gases shall be marked with an unbroken, orange⁴, non-reflectorized band, about 30cm wide, encircling the shell at mid-height.

5.3.6 Environmentally hazardous substance mark

When a placard is required to be displayed in accordance with the provisions of 5.3.1, large containers, MEGCs, tank-containers, portable tanks and wagons containing environmentally hazardous substances meeting the criteria of 2.2.9.1.10 shall be marked with the environmentally hazardous substance mark shown in 5.2.1.8.3. The provisions of section 5.3.1 concerning placards shall apply mutatis mutandis to the mark.

⁴ See 5.3.2.2.1 NOTE.

Chapter 5.4

Documentation

5.4.0 General

5.4.0.1 Unless otherwise specified, any carriage of goods governed by RID shall be accompanied by the documentation prescribed in this Chapter, as appropriate.

5.4.0.2 The use of electronic data processing (EDP) or electronic data interchange (EDI) techniques as an aid to or instead of paper documentation is permitted, provided that the procedures used for the capture, storage and processing of electronics data meet the legal requirements as regards the evidential value and availability of data during transport in a manner at least equivalent to that of paper documentation.

5.4.0.3 When the dangerous goods transport information is given to the carrier by EDP or EDI techniques, the consignor shall be able to give the information to the carrier as a paper document, with the information in the sequence required by this Chapter.

5.4.1 Dangerous goods transport document and related information

5.4.1.1 General information required in the transport document

5.4.1.1.1 Next to the cross to be entered in the appropriate box, the transport document(s) shall contain the following information for each dangerous substance, material or article handed over for carriage,

- (a) the UN number preceded by the letters "UN";
- (b) the proper shipping name supplemented, when applicable (see 3.1.2.8.1) with the technical name in brackets (see 3.1.2.8.1.1), as determined in accordance with 3.1.2;
- (c) – for substances and articles of Class 1: the classification code given in Column (3 b) of Table A in Chapter 3.2.

When, in Column (5) of Table A of Chapter 3.2, label model numbers other than 1, 1.4, 1.5, 1.6, 13 or 15 are given, these label model numbers, in brackets, shall follow the classification code;

- for radioactive material of Class 7: the Class number "7";

NOTE: For radioactive material with a subsidiary risk, see also special provision 172 in Chapter 3.3.

- for substances and articles of other classes: the label model numbers, apart from the shunting label conforming to model number 13, given in Column (5) of Table A in Chapter 3.2 or applicable according to a special provision referred to in Column (6). When more than one label model numbers are given, the numbers following the first one shall be given in brackets. For substances and articles for which no label model is given in Column (5) of Table A in Chapter 3.2, their class according to Column (3a) shall be given instead;
- (d) where assigned, the packing group for the substance which may be preceded by the letters "PG" (e.g. "PG II"), or the initials corresponding to the words "Packing Group" in the languages used according to 5.4.1.4.1;

NOTE: For radioactive material of Class 7 with subsidiary risks, see special provision 172 (b) in Chapter 3.3.

- (e) the number and a description of the packages when applicable (see also CIM Article 7 § 1 (h) and (i)); UN packaging codes may only be used to supplement the description of the kind of package (e.g. one box (4G));

NOTE: The number, type and capacity of each inner packaging within the outer packaging of a combination packaging is not required to be indicated.

- (f) the total quantity of each type of dangerous goods bearing a different UN number, proper shipping name or packing group (as a volume or as a gross mass, or as a net mass as appropriate);

NOTE 1: (Reserved)

2: For dangerous goods in machinery or equipment specified in RID, the quantity indicated shall be the total quantity of dangerous goods contained therein in kilograms or litres as appropriate.

- (g) the name and address of the consignor (see also CIM Article 7 § 1 (b));
- (h) the name and address of the consignee(s) (see also CIM Article 7 § 1 (g));
- (i) a declaration as required by the terms of any special agreement;
- (j) when a marking in accordance with 5.3.2.1 is prescribed, the hazard identification number shall also be inscribed before the UN number. The hazard identification number shall also be shown where full wagon loads made up of packages containing one and the same substance are marked in accordance with 5.3.2.1.

The location and order in which the elements of information required appear in the transport document is left optional, except that (a), (b), (c) and (d) shall be shown in the order listed above (i.e. (a), (b), (c), (d)) with no information interspersed, except as provided in RID.

Examples of such permitted dangerous goods descriptions are:

"UN 1098 ALLYL ALCOHOL, 6.1 (3), I" or

"UN 1098 ALLYL ALCOHOL, 6.1 (3), PG I"

When a marking in accordance with 5.3.2.1 is required, (a), (b), (c), (d), and (j) shall be shown in the sequence (j), (a), (b), (c), (d) with no information interspersed, except as provided in RID.

Examples of such permitted dangerous goods descriptions taking account of the marking in accordance with 5.3.2.1 are:

"663, UN 1098 ALLYL ALCOHOL, 6.1(3), I" or

"663, UN 1098 ALLYL ALCOHOL, 6.1(3), PG I".

5.4.1.1.2 The information required on a transport document shall be legible.

Although upper case is used in Chapter 3.1 and in Table A in Chapter 3.2 to indicate the elements which shall be part of the proper shipping name, and although upper and lower case are used in this Chapter to indicate the information required in the transport document, the use of upper or of lower case for entering the information in the transport document is left optional.

5.4.1.1.3 Special provisions for wastes

If waste containing dangerous goods (other than radioactive wastes) is being **carried, the** proper shipping name shall be preceded by the word "WASTE", unless this term is part of the proper shipping name, e.g.

– "**UN 1230 WASTE** METHANOL, 3 (6.1), II" or

– "**UN 1230 WASTE** METHANOL, 3 (6.1), PG II" or

– "**UN 1993 WASTE** FLAMMABLE LIQUID, N.O.S. (toluene and ethyl alcohol), 3, II" or

– "**UN 1993 WASTE** FLAMMABLE LIQUID, N.O.S. (toluene and ethyl alcohol), 3, PG II".

If the provision for waste as set out in 2.1.3.5.5 is applied, the following shall be added to the proper shipping name:

"WASTE IN ACCORDANCE WITH 2.1.3.5.5" (e.g. "UN 3264, CORROSIVE LIQUID, ACIDIC, INORGANIC, N.O.S., 8, II, WASTE IN ACCORDANCE WITH 2.1.3.5.5").

The technical name, as prescribed in Chapter 3.3, special provision 274, need not be added.

5.4.1.1.4 **(Deleted)**

5.4.1.1.5 Special provisions for salvage packagings

When dangerous goods are carried in a salvage packaging, the words "SALVAGE PACKAGE" shall be added after the description of the goods in the transport document.

5.4.1.1.6 Special provisions for empty means of containment, uncleaned

5.4.1.1.6.1 For empty means of containment, uncleaned, which contain the residue of dangerous goods of classes other than Class 7, the words "**EMPTY, UNCLEANED**" or "**RESIDUE, LAST CONTAINED**" shall be indicated before or after the **dangerous goods description specified in 5.4.1.1.1 (j) and (a) to (d)**. Moreover, 5.4.1.1.1 (f) does not apply.

5.4.1.1.6.2 The special provision of 5.4.1.1.6.1 may be replaced with the provisions of 5.4.1.1.6.2.1 or 5.4.1.1.6.2.2, as appropriate.

5.4.1.1.6.2.1 For empty packagings, uncleaned, which contain the residue of dangerous goods of classes other than Class 7, including empty uncleaned receptacles for gases with a capacity of not more than 1000 litres, the particulars according to 5.4.1.1.1 (a), (b), (c), (d), (e), (f) and (j) are replaced with "EMPTY PACKAGING", "EMPTY RECEPTACLE", "EMPTY IBC" or "EMPTY LARGE PACKAGING", as appropriate, followed by the information of the goods last loaded, as described in 5.4.1.1.1 (c).

See example as follows: "EMPTY PACKAGING, 6.1 (3)".

In addition, in such a case, if the dangerous goods last loaded are goods of Class 2, the information prescribed in 5.4.1.1.1 (c) may be replaced by the number of the class "2".

5.4.1.1.6.2.2 For empty means of containment other than packagings, uncleaned, which contain the residue of dangerous goods of classes other than Class 7 and for empty uncleaned receptacles for gases with a capacity of more than 1000 litres, the particulars according to 5.4.1.1.1 (a) to (d) and (j) are preceded by "EMPTY TANK-WAGON", "EMPTY TANK-VEHICLE", "EMPTY DEMOUNTABLE TANK", "EMPTY BATTERY-WAGON", "EMPTY BATTERY-VEHICLE", "EMPTY PORTABLE TANK", "EMPTY TANK-CONTAINER", "EMPTY MEGC", "EMPTY WAGON", "EMPTY VEHICLE", "EMPTY CONTAINER" or "EMPTY RECEPTACLE", as appropriate, followed by the words "LAST LOAD:". Moreover, paragraph 5.4.1.1.1 (f) does not apply.

See examples as follows:

"EMPTY TANK-WAGON, LAST LOAD: 663 UN 1098 ALLYL ALCOHOL, 6.1 (3), I" or

"EMPTY TANK-WAGON, LAST LOAD: 663 UN 1098 ALLYL ALCOHOL, 6.1 (3), PG I".

5.4.1.1.6.2.3 (Reserved)

5.4.1.1.6.3 (a) If empty tanks, battery-wagons, battery-vehicles and MEGCs, uncleaned, are carried to the nearest place where cleaning or repair can be carried out in accordance with the provisions of 4.3.2.4.3, the following additional entry shall be made in the transport document:

"CARRIAGE IN ACCORDANCE WITH 4.3.2.4.3".

(b) If empty wagons, vehicles and containers, uncleaned, are carried to the nearest place where cleaning or repair can be carried out in accordance with the provisions of 7.5.8.1, the following additional entry shall be made in the transport document:

"CARRIAGE IN ACCORDANCE WITH 7.5.8.1".

5.4.1.1.6.4 For the carriage of tank-wagons, demountable tanks, battery-wagons, tank-containers and MEGCs under the conditions of 4.3.2.4.4, the following entry shall be included in the transport document:

"CARRIAGE IN ACCORDANCE WITH 4.3.2.4.4."

5.4.1.1.7 **Special provisions for carriage in a transport chain including maritime or air carriage⁵**

For carriage in accordance with 1.1.4.2.1, a statement shall be included in the transport document, as follows:

"CARRIAGE IN ACCORDANCE WITH 1.1.4.2.1".

5.4.1.1.8 (Reserved)

5.4.1.1.9 **Special provisions for piggyback transport**

NOTE: For the information in the transport document, see 1.1.4.4.5.

5.4.1.1.10 (Reserved)

5.4.1.1.11 **Special provisions for the carriage of IBCs or portable tanks after the date of expiry of the last periodic test or inspection**

For carriage in accordance with 4.1.2.2 (b), 6.7.2.19.6 (b), 6.7.3.15.6 (b) or 6.7.4.14.6 (b), a statement to this effect shall be included in the transport document, as follows:

"CARRIAGE IN ACCORDANCE WITH 4.1.2.2 (b)",

"CARRIAGE IN ACCORDANCE WITH 6.7.2.19.6 (b)",

"CARRIAGE IN ACCORDANCE WITH 6.7.3.15.6 (b)" or

"CARRIAGE IN ACCORDANCE WITH 6.7.4.14.6 (b)" as appropriate.

5.4.1.1.12 **Special provisions for carriage in accordance with transitional requirements**

For carriage in accordance with 1.6.1.1, a statement shall be included in the transport document, as follows:

"CARRIAGE IN ACCORDANCE WITH RID IN FORCE BEFORE 1 JANUARY 2011".

⁵ For carriage in a transport chain including maritime or air carriage, a copy of the documentation (e.g. form for the multimodal transport of dangerous goods in accordance with 5.4.5) prescribed for maritime or air carriage may be attached to the transport document. These documents shall be the same size as the transport document. If the form for the multimodal transport of dangerous goods in accordance with 5.4.5 is attached to the transport document, the information concerning the dangerous goods already contained on this form need not be shown in the transport document, but a reference to this supplementary sheet shall be entered in the appropriate box on the transport document.

5.4.1.1.13 (Reserved)

5.4.1.1.14 Special provisions for the carriage of substances carried under elevated temperature

If the proper shipping name of a substance which is carried or offered for carriage in a liquid state at a temperature equal to or exceeding 100 °C, or in a solid state at a temperature equal to or exceeding 240 °C, does not convey the elevated temperature condition (for example, by using the term "MOLTEN" or "ELEVATED TEMPERATURE" as part of the proper shipping name), the word "HOT" shall immediately precede the proper shipping name.

5.4.1.1.15 (Reserved)

5.4.1.1.16 Information required in accordance with special provision 640 in Chapter 3.3

Where it is required by special provision 640 of Chapter 3.3, the transport document shall bear the inscription "SPECIAL PROVISION 640X" where "X" is the capital letter appearing after the pertinent reference to special provision 640 in column (6) of Table A of Chapter 3.2.

5.4.1.1.17 Special provisions for the carriage of solids in bulk containers conforming to 6.11.4

When solid substances are carried in bulk containers conforming to 6.11.4, the following statement shall be shown in the transport document (see Note at the beginning of 6.11.4):

"BULK CONTAINER BK(X) APPROVED BY THE COMPETENT AUTHORITY OF ...".

5.4.1.1.18 Special provisions for carriage of environmentally hazardous substances (aquatic environment)

When a substance belonging to one of classes 1 to 9 meets the classification criteria of 2.2.9.1.10, the transport document shall bear the additional inscription "ENVIRONMENTALLY HAZARDOUS". This additional requirement does not apply to UN Nos. 3077 and 3082 or for the exceptions listed in 5.2.1.8.1.

The inscription "MARINE POLLUTANT" (according to 5.4.1.4.3 of the IMDG Code) instead of "ENVIRONMENTALLY HAZARDOUS" is acceptable for carriage in a transport chain including maritime carriage.

5.4.1.2 Additional or special information required for certain classes

5.4.1.2.1 Special provisions for Class 1

- (a) For wagon loads or full wagon loads, the transport document shall indicate the number of packages, the mass of each package in kg and the total net mass in kg of explosive substance. In addition to the information in accordance with 5.4.1.1.1 (f), the transport document shall indicate the net mass in kg of explosive substance;
- (b) For mixed packing of two different goods, the description of the goods in the transport document shall include the UN numbers and names printed in capitals in Columns (1) and (2) of Table A of Chapter 3.2 of both substances or articles. If more than two different goods are contained in the same package in conformity with the mixed packing provisions given in 4.1.10 special provisions MP1, MP2 and MP20 to MP24, the transport document shall indicate under the description of the goods the UN numbers of all the substances and articles contained in the package, in the form, "GOODS OF UN NOS ...";
- (c) For the carriage of substances and articles assigned to an n.o.s. entry or the entry "0190 SAMPLES, EXPLOSIVE" or packed conforming to packing instruction P101 of 4.1.4.1, a copy of the competent authority approval with the conditions of carriage shall be attached to the transport document. It shall be drafted in an official language of the forwarding country and also, if that language is not English, French, German or Italian, in English, French, German or Italian, unless any agreements concluded between the countries concerned in the transport operation provide otherwise;
- (d) If packages containing substances and articles of compatibility groups B and D are loaded together in the same wagon in accordance with the requirements of 7.5.2.2, a copy of the competent authority approval of the protective compartment or containment system in accordance with 7.5.2.2, footnote (a) under the table, shall be attached to the transport document. It shall be drafted in an official language of the forwarding country and also, if that language is not English, French, German or Italian, in English, French, German or Italian unless any agreements concluded between the countries concerned in the transport operation provide otherwise;
- (e) When explosive substances or articles are carried in packagings conforming to packing instruction P101, the transport document shall bear the inscription "PACKAGING APPROVED BY THE COMPETENT AUTHORITY OF (indication of the state (distinguishing sign of the states for motor vehicles in international traffic), on whose behalf the competent authority is acting)" (see 4.1.4.1, packing instruction P101);
- (f) In the case of military consignments within the meaning of 1.5.2, the descriptions prescribed by the competent military authority may be used in place of the descriptions in accordance with Table A of Chapter 3.2.

For the carriage of military consignments to which the derogations in accordance with 5.2.1.5, 5.2.2.1.8 and 5.3.1.1.2 and in 7.2.4, special provision W2, the following shall be entered in the transport document: "MILITARY CONSIGNMENT".

- (g) When fireworks of UN Nos. 0333, 0334, 0335, 0336 and 0337 are carried, the transport document shall bear the inscription:

"CLASSIFICATION OF FIREWORKS BY THE COMPETENT AUTHORITY OF XX WITH THE FIREWORK REFERENCE XX/YYZZZZ".

The classification approval certificate need not be carried with the consignment, but shall be made available by the consignor to the carrier or the competent authorities for control purposes. The classification approval certificate or a copy of it shall be in an official language of the forwarding country, and also, if that language is not German, English, French or Italian, in German, English, French or Italian.

NOTE 1: The commercial or technical name of the goods may be entered additionally to the proper shipping name in the transport document.

2: The classification reference(s) shall consist of the RID Contracting State in which the classification code according to special provision 645 of 3.3.1 was approved, indicated by the distinguishing sign for motor vehicles in international traffic (XX)⁶, the competent authority identification (YY) and a unique serial reference (ZZZZ). Examples of such classification references are:

GB/HSE123456

D/BAM1234.

5.4.1.2.2 Additional provisions for Class 2

- (a) For the carriage of mixtures (see 2.2.2.1.1) in tank-wagons, battery-wagons, wagons with demountable tanks, portable tanks, tank-containers or MEGCs, the composition of the mixture as a percentage of the volume or as a percentage of the mass shall be given. Constituents below 1% need not be indicated (see also 3.1.2.8.1.2). The composition of the mixture need not be given when the technical names authorized by special provisions 581, 582 or 583 are used to supplement the proper shipping name;
- (b) For the carriage of cylinders, tubes, pressure drums, cryogenic receptacles and bundles of cylinders under the conditions of 4.1.6.10, the following entry shall be included in the transport document:
"CARRIAGE IN ACCORDANCE WITH 4.1.6.10".
- (c) Where tank-wagons have been refilled without having been previously cleaned out, the transport document shall show, as total weight of goods carried, the sum of the weight of the new load and of the residual load, which will be the same as the gross weight of the tank-wagon, less its registered unladen weight. In addition, the words "MASS OF NEW LOAD ... KG" may also be added.
- (d) In the case of tank-wagons, portable tanks and tank-containers containing refrigerated liquefied gases, the consignor shall enter in the transport document:
"THE TANK IS GUARANTEED AS INSULATED IN ORDER THAT THE SAFETY VALVES CANNOT OPEN BEFORE ... (date accepted by the railway)".

5.4.1.2.3 Additional provisions for self-reactive substances of Class 4.1 and organic peroxides of Class 5.2

5.4.1.2.3.1 (Reserved)

5.4.1.2.3.2 When for certain self-reactive substances of Class 4.1 and certain organic peroxides of Class 5.2 the competent authority has permitted the label conforming to model No.1 to be dispensed with for a specific packaging (see 5.2.2.1.9), a statement to this effect shall be included in the transport document, as follows:

"THE LABEL CONFORMING TO MODEL NO.1 IS NOT REQUIRED".

5.4.1.2.3.3 When organic peroxides and self-reactive substances are carried under conditions where approval is required (for organic peroxides see 2.2.52.1.8, 4.1.7.2.2 and special provision TA2 of 6.8.4; for self-reactive substances see 2.2.41.1.13 and 4.1.7.2.2, a statement to his effect shall be included in the transport document, e.g.

"CARRIAGE IN ACCORDANCE WITH 2.2.52.1.8".

A copy of the competent authority approval with the conditions of carriage shall be attached to the transport document. It shall be drafted in an official language of the forwarding country and also, if that language is not English, French, German or Italian, in English, French, German or Italian unless any agreements concluded between the countries concerned in the transport operation provide otherwise.

⁶ Distinguishing sign for motor vehicles in international traffic prescribed in the Vienna Convention on Road Traffic (1968).

5.4.1.2.3.4 When a sample of an organic peroxide (see 2.2.52.1.9) or a self-reactive substance (see 2.2.41.1.15) is carried, a statement to this effect shall be included in the transport document, e.g.

"CARRIAGE IN ACCORDANCE WITH 2.2.52.1.9".

5.4.1.2.3.5 When self-reactive substances type G (see Manual of Tests and Criteria, Part II, paragraph 20.4.2 (g)) are carried, the following statement may be given in the transport document:

"NOT A SELF-REACTIVE SUBSTANCE OF CLASS 4.1".

When organic peroxides type G (see Manual of Tests and Criteria, Part II, paragraph 20.4.3 (g)) are carried, the following statement may be given in the transport document:

"NOT A SUBSTANCE OF CLASS 5.2".

5.4.1.2.4 Additional provisions for Class 6.2

In addition to the information concerning the consignee (see 5.4.1.1.1 (h)), the name and telephone number of a responsible person shall be indicated.

5.4.1.2.5 Additional provisions for Class 7

5.4.1.2.5.1 The following information shall be inserted in the transport document for each consignment of Class 7 material, as applicable, in the order given and immediately after the information required under 5.4.1.1.1 (a) to (c):

- (a) The name or symbol of each radionuclide or, for mixtures of radionuclides, an appropriate general description or a list of the most restrictive nuclides;
- (b) A description of the physical and chemical form of the material, or a notation that the material is special form radioactive material or low dispersible radioactive material. A generic chemical description is acceptable for chemical form. For radioactive material with a subsidiary risk, see last sentence of special provision 172 of Chapter 3.3;
- (c) The maximum activity of the radioactive contents during carriage expressed in becquerels (Bq) with an appropriate SI prefix symbol (see 1.2.2.1). For fissile material, the mass of fissile material (or mass of each fissile nuclide for mixtures when appropriate) in grams (g), or appropriate multiples thereof, may be used in place of activity;
- (d) The category of the package, i.e. I-WHITE, II-YELLOW, III-YELLOW;
- (e) The transport index (categories II-YELLOW and III-YELLOW only);
- (f) For consignments including fissile material other than consignments excepted under 6.4.11.2, the criticality safety index;
- (g) The identification mark for each competent authority approval certificate (special form radioactive material, low dispersible radioactive material, special arrangement, package design, or shipment) applicable to the consignment;
- (h) For consignments of more than one package, the information required in 5.4.1.1.1 and in (a) to (g) above shall be given for each package. For packages in an overpack, container or wagon, a detailed statement of the contents of each package within the overpack, container or wagon and, where appropriate, of each overpack, container or wagon shall be included. If packages are to be removed from the overpack, container or wagon at a point of intermediate unloading, appropriate transport documents shall be made available;
- (i) Where a consignment is required to be shipped under exclusive use, the statement "EXCLUSIVE USE SHIPMENT"; and
- (j) For LSA-II and LSA-III substances, SCO-I and SCO-II, the total activity of the consignment as a multiple of A_2 . For radioactive material for which the A_2 value is unlimited, the multiple of A_2 shall be zero.

5.4.1.2.5.2 The consignor shall provide in the transport document a statement regarding actions, if any, that are required to be taken by the carrier. The statement shall be in the languages deemed necessary by the carrier or the authorities concerned, and shall include at least the following information:

- (a) Supplementary requirements for loading, stowage, carriage, handling and unloading of the package, overpack or container including any special stowage provisions for the safe dissipation of heat (see special provision CW33 (3.2) of 7.5.11), or a statement that no such requirements are necessary;
- (b) Restrictions on the mode of carriage or wagon and any necessary routing instructions;
- (c) Emergency arrangements appropriate to the consignment.

5.4.1.2.5.3 In all cases of international carriage of packages requiring competent authority design or shipment approval, for which different approval types apply in the different countries concerned by the shipment, the UN number and proper shipping name required in 5.4.1.1.1 shall be in accordance with the certificate of the country of origin of design.

5.4.1.2.5.4 The applicable competent authority certificates need not necessarily accompany the consignment. The consignor shall make them available to the carrier(s) before loading and unloading.

5.4.1.3 (Reserved)

5.4.1.4 Format and language to be used

5.4.1.4.1 The transport document shall be filled out in one or more languages, one of which shall be English, French or German, unless any agreements concluded between the countries concerned in the transport operation provide otherwise.

5.4.1.4.2 A separate transport document shall be made out for consignments which, because of the prohibitions in 7.5.2, may not be loaded together in the same wagon or container.

In addition to the transport document, for multimodal carriage, the use of documents corresponding to the example shown in 5.4.5 is considered advisable⁷.

5.4.1.5 Non-dangerous goods

When goods mentioned by name in Table A of Chapter 3.2, are not subject to RID because they are considered as non-dangerous according to Part 2, the consignor may enter in the transport document a statement to that effect, e.g.:

"NOT GOODS OF CLASS ...".

NOTE: This provision may be used in particular when the consignor considers that, due to the chemical nature of the goods (e.g. solutions and mixtures) carried or to the fact that such goods are deemed dangerous for other regulatory purposes the consignment might be subject to control during the journey.

5.4.2 Large container or wagon packing certificate

If the carriage of dangerous goods in a large container precedes a voyage by sea, a container/vehicle packing certificate conforming to section 5.4.2 of the IMDG Code⁸ shall be provided with the transport document⁹.

⁷ If used, the relevant recommendations of the UNECE United Nations Centre for Trade Facilitation and Electronic Business (UN/CEFACT) may be consulted, in particular Recommendation No. 1 (United Nations Layout Key for Trade Documents) (ECE/TRADE/137, edition 81.3), UN Layout Key for Trade Documents – Guidelines for Applications (ECE/TRADE/270, edition 2002), Recommendation No. 11 (Documentary Aspects of the International Transport of Dangerous Goods) (ECE/TRADE/204, edition 96.1 – currently under revision) and Recommendation No. 22 (Layout Key for Standard Consignment Instructions) (ECE/TRADE/168, edition 1989). Refer also to the UN/CEFACT Summary of Trade Facilitation Recommendations (ECE/TRADE/346, edition 2006) and the United Nations Trade Data Elements Directory (UNTDDED) (ECE/TRADE/362, edition 2005).

⁸ Guidelines for use in practice and in training for loading goods in transport units have also been drawn up by the International Maritime Organization (IMO), the International Labour Organization (ILO) and the United Nations Economic Commission for Europe (UNECE) and have been published by IMO ("IMO/ILO/UNECE Guidelines for Packing of Cargo Transport Units (CTUs)").

⁹ Section 5.4.2 of the IMDG Code requires the following:

"5.4.2 Container/vehicle packing certificate

5.4.2.1 When dangerous goods are packed or loaded into any container or vehicle, those responsible for packing the container or vehicle shall provide a "container/vehicle packing certificate" specifying the container/vehicle identification number(s) and certifying that the operation has been carried out in accordance with the following conditions:

- .1 The container/vehicle was clean, dry and apparently fit to receive the goods;
- .2 Packages, which need to be segregated in accordance with applicable segregation requirements, have not been packed together onto or in the container/vehicle [unless approved by the competent authority concerned in accordance with 7.2.2.3 (of the IMDG Code)];
- .3 All packages have been externally inspected for damage, and only sound packages have been loaded;
- .4 Drums have been stowed in an upright position, unless otherwise authorized by the competent authority, and all goods have been properly loaded, and, where necessary, adequately braced with securing material to suit the mode(s) of transport for the intended journey;

The functions of the transport document required under 5.4.1 and of the container/vehicle packing certificate as provided above may be incorporated into a single document; if not, these documents shall be attached one to the other. If these functions are incorporated into a single document, the inclusion in the transport document of a statement that the loading of the container has been carried out in accordance with the applicable modal regulations together with the identification of the person responsible for the container/vehicle packing certificate shall be sufficient.

NOTE: The container/vehicle packing certificate is not required for portable tanks, tank-containers and MEGCs.

5.4.3 Instructions in writing

5.4.3.1 As an aid during an emergency situation that may occur during carriage, instructions in writing in the form specified in 5.4.3.4 shall be carried in the driver's cab and shall be readily available.

5.4.3.2 Before the start of the journey, these instructions shall be provided by the carrier to the driver(s) in (a) language(s) that he (they) can read and understand. The carrier shall ensure that the driver understands the instructions and is capable of carrying them out properly.

5.4.3.3 Before the start of the journey, the carrier shall inform the driver of the dangerous goods loaded. The driver shall consult the instructions in writing for details on actions to be taken in the event of an accident or incident.

5.4.3.4 The instructions in writing should correspond to the following four page model as regards their contents.

-
- .5 Goods loaded in bulk have been evenly distributed within the container/vehicle;
 - .6 For consignments including goods of class 1, other than division 1.4, the container/vehicle is structurally serviceable in conformity with 7.4.6 (of the IMDG Code);
 - .7 The container/vehicle and packages are properly marked, labelled, and placarded, as appropriate;
 - .8 When solid carbon dioxide (CO₂-dry ice) is used for cooling purposes, the container/vehicle is externally marked or labelled in a conspicuous place, such as, at the door end, with the words: "DANGEROUS CO₂ GAS (DRY ICE) INSIDE. VENTILATE THOROUGHLY BEFORE ENTERING"; and
 - .9 A dangerous goods transport document, as indicated in 5.4.1 (of the IMDG Code) has been received for each dangerous goods consignment loaded in the container/vehicle.

NOTE: The container/vehicle packing certificate is not required for tanks.

5.4.2.2 The information required in the dangerous goods transport document and the container/vehicle packing certificate may be incorporated into a single document; if not, these documents shall be attached one to the other. If the information is incorporated into a single document, the document shall include a signed declaration such as "It is declared that the packing of the goods into the container/vehicle has been carried out in accordance with the applicable provisions". This declaration shall be dated and the person signing this declaration shall be identified on the document. Facsimile signatures are acceptable where applicable laws and regulations recognize the legal validity of facsimile signatures.

5.4.2.3 If the dangerous goods documentation is presented to the carrier by means of EDP or EDI transmission techniques, the signature(s) may be electronic signature(s) or may be replaced by the name(s) (in capitals) of the person authorized to sign.

5.4.2.4 When the dangerous goods transport information is given to a carrier by EDP or EDI techniques and subsequently the dangerous goods are transferred to a carrier that requires a paper dangerous goods transport document, the carrier shall ensure that the paper document indicates "Original received electronically" and the name of the signatory shall be shown in capital letters."









INSTRUCTIONS IN WRITING ACCORDING TO RID









Actions in the event of an accident or incident involving or likely to involve dangerous goods

In the event of an accident or incident that may occur or arise during carriage, the drivers shall take the following actions where safe and practicable to do so^a:

- Bring the train/shunting movement to a stop in a suitable place, bearing in mind the type of hazard (e.g. fire, loss of load), the local conditions (e.g. tunnel, built-up area) and possible actions by the emergency services (accessibility, evacuation), if necessary, by agreement with the railway infrastructure manager;
- Switch off the locomotive in accordance with the operating instructions;
- Avoid sources of ignition, in particular, do not smoke or switch on any electrical equipment;
- Observe the additional guidance assigned to the hazards of all concerned goods in the following table. The hazards correspond to the number of the danger label model and the mark assigned to the goods during carriage;
- Inform the railway infrastructure manager or the emergency services, giving as much information as possible about the accident or incident and dangerous goods involved, bearing in mind the carrier's instructions;
- Keep information on the dangerous goods being carried (if necessary, the transport documents) readily available for the emergency services on arrival, or have these made available by means of electronic data interchange (EDI);
- When leaving the locomotive, put on the prescribed warning clothing;
- If necessary, use other protective equipment;
- Move away from the immediate vicinity of the accident or incident, advise other persons to move away and follow the advice of the officers-in-charge (internal and external);
- Do not walk into or touch spilled substances and avoid inhalation of fumes, smoke, dusts and vapours by staying up wind;
- Remove any contaminated clothing and dispose of it safely.

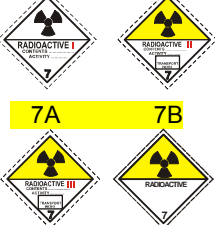

^a Specifications contained in railway regulations or railway operations shall be observed.

Additional guidance to drivers on the hazard characteristics of dangerous goods by class and on actions subject to prevailing circumstances		
Danger labels and placards, description of the hazards	Hazard characteristics	Additional guidance
(1)	(2)	(3)
Explosive substances and articles  1.5 1.6	Kann eine Reihe von Eigenschaften und Auswirkungen wie Massendetonation, Splitterwirkung, starker Brand/Wärmefluss, Bildung von hellem Licht, Lärm oder Rauch haben. Schlagempfindlich und/oder stoßempfindlich und/oder wärmeempfindlich.	Schutz abseits von Fenstern suchen.
Explosive substances and articles  1.4	Slight risk of explosion and fire.	Take cover.
Flammable gases  2.1	Risk of fire. Risk of explosion. May be under pressure. Risk of asphyxiation. May cause burns and/or frostbite. Containments may explode when heated.	Take cover. Keep out of low areas.
Non-flammable, non-toxic gases  2.2	Risk of asphyxiation. May be under pressure. May cause frostbite. Containments may explode when heated.	Take cover. Keep out of low areas.
Toxic gases  2.3	Risk of intoxication. May be under pressure. May cause burns and/or frostbite. Containments may explode when heated.	Take cover. Keep out of low areas.
Flammable liquids  3	Risk of fire. Risk of explosion. Containments may explode when heated.	Take cover. Keep out of low areas.
Flammable solids, self-reactive substances and solid desensitized explosives  4.1	Risk of fire. Flammable or combustible, may be ignited by heat, sparks or flames. May contain self-reactive substances that are liable to exothermic decomposition in the case of heat supply, contact with other substances (such as acids, heavy-metal compounds or amines), friction or shock. This may result in the evolution of harmful and flammable gases or vapours or self-ignition. Containments may explode when heated. Risk of explosion of desensitized explosives after loss of desensitizer.	
Substances liable to spontaneous combustion  4.2	Risk of fire by spontaneous combustion if packages are damaged or contents spilled. May react vigorously with water.	
Substances which, in contact with water, emit flammable gases  4.3	Risk of fire and explosion in contact with water.	

Additional guidance to drivers on the hazard characteristics of dangerous goods by class and on actions subject to prevailing circumstances		
Danger labels and placards, description of the hazards	Danger labels and placards, description of the hazards	Danger labels and placards, description of the hazards
(1)	(2)	(3)
<p>Oxidizing substances</p>  <p>5.1</p>	<p>Risk of vigorous reaction, ignition and explosion in contact with combustible or flammable substances.</p>	
<p>Organic peroxides</p>  <p>5.2</p>	<p>Risk of exothermic decomposition at elevated temperatures, contact with other substances (such as acids, heavy-metal compounds or amines), friction or shock. This may result in the evolution of harmful and flammable gases or vapours or self-ignition.</p>	
<p>Toxic substances</p>  <p>6.1</p>	<p>Risk of intoxication by inhalation, skin contact or ingestion.</p> <p>Risk to the aquatic environment or the sewage system.</p>	
<p>Infectious substances</p>  <p>6.2</p>	<p>Risk of infection.</p> <p>May cause serious disease in humans or animals.</p> <p>Risk to the aquatic environment or the sewage system.</p>	
<p>Radioactive material</p>  <p>7A 7B</p> <p>7C 7D</p>	<p>Risk of intake and external radiation.</p>	<p>Limit time of exposure.</p>
<p>Fissile material</p>  <p>7E</p>	<p>Risk of nuclear chain reaction.</p>	
<p>Corrosive substances</p>  <p>8</p>	<p>Risk of burns by corrosion.</p> <p>May react vigorously with each other, with water and with other substances.</p> <p>Spilled substance may evolve corrosive vapours.</p> <p>Risk to the aquatic environment or the sewage system.</p>	
<p>Miscellaneous dangerous substances and articles</p>  <p>9</p>	<p>Risk of fire.</p> <p>Risk of explosion.</p> <p>Risk to the aquatic environment or the sewage system.</p>	

NOTE 1: For dangerous goods with multiple risks and for mixed loads, each applicable entry shall be observed.

2: Additional guidance shown above may be adapted to reflect the classes of dangerous goods to be carried and their means of transport and, if necessary, to supplement them according to existing national specifications.

Additional guidance to drivers on the hazard characteristics of dangerous goods, indicated by marks, and on actions subject to prevailing circumstances		
Mark (1)	Hazard characteristics (2)	Additional guidance (3)
 Environmentally hazardous substances	Risk to the aquatic environment or the sewage system.	
 Elevated temperature substances	Risk of burns by heat.	Avoid contact with hot parts of the wagon or container and the spilled substance.

Equipment for personal protection to be carried in the driver's cab

The following equipment^a shall be carried in the driver's cab:

- portable lighting apparatus;

for the driver

- suitable warning clothing (e.g. as described in standard EN 471).

^a The equipment to be kept available shall, if necessary, be supplemented according to existing national specifications.

5.4.4 Retention of dangerous goods transport information

5.4.4.1 The consignor and the carrier shall retain a copy of the dangerous goods transport document and additional information and documentation as specified in RID, for a minimum period of three months.

5.4.4.2 When the documents are kept electronically or in a computer system, the consignor and the carrier shall be able to reproduce them in a printed form.

5.4.5 Example of a multimodal dangerous goods form

Example of a form which may be used as a combined dangerous goods declaration and container packing certificate for multimodal carriage of dangerous goods.

MULTIMODAL DANGEROUS GOODS FORM (right edge black hatchings)

1. Shipper/Consignor/Sender		2. Transport document number			
		3. Page 1 of ... Pages	4. Shipper's reference		
		5. Freight Forwarder's reference			
6. Consignee		7. Carrier (to be completed by the carrier)			
		SHIPPER'S DECLARATION I hereby declare that the contents of this consignment are fully and accurately described below by the proper shipping name, and are classified, packaged, marked and labeled /placarded and are in all respects in proper condition for transport according to the applicable international and national governmental regulations.			
8. This shipment is within the limitations prescribed for: (Delete non-applicable)		9. Additional handling information			
PASSENGER AND CARGO AIRCRAFT		CARGO AIRCRAFT ONLY			
10. Vessel/flight no. and date	11. Port/place of loading				
12. Port/place of discharge	13. Destination				
14. Shipping marks		* Number and kind of packages; description of goods	Gross mass (kg)	Net mass	
				Cube (m ³)	
* FOR DANGEROUS GOODS: you must specify: UN No., proper shipping name, hazard class, packing group (where assigned) and any other element of information required under applicable national and international regulations.					
15. Container identification No./vehicle registration No.	16. Seal number (s)	17. Container/vehicle size & type	18. Tare (kg)	19. Total gross mass (including tare) (kg)	
CONTAINER/VEHICLE PACKING CERTIFICATE I hereby declare that the goods described above have been packed/loaded into the container/vehicle identified above in accordance with the applicable provisions**. MUST BE COMPLETED AND SIGNED FOR ALL CONTAINER/VEHICLE LOADS BY PERSON RESPONSIBLE FOR PACKING/LOADING		21. RECEIVING ORGANISATION RECEIPT Received the above number of packages/containers/trailers in apparent good order and condition unless stated hereon: RECEIVING ORGANISATION REMARKS:			
		20. Name of company		Haulier's name	22. Name of company (OF SHIPPER PREPARING THIS NOTE)
		Name/Status of declarant		Vehicle reg. no.	Name/Status of declarant
		Place and date		Signature and date	Place and date
		Signature of declarant		DRIVER'S SIGNATURE	Signature of declarant

** See 5.4.2.

MULTIMODAL DANGEROUS GOODS FORM**Continuation Sheet**

(right edge black hatchings)

1. Shipper/Consignor /Sender	2. Transport document number		
	3. Page 2 of ... Pages	4. Shipper's reference	
		5. Freight Forwarder's reference	

14. Shipping marks	* Number and kind of packages; description of goods	Gross mass (kg)	Net mass	Cube (m ³)
--------------------	-----------------------------------------------------	-----------------	----------	------------------------

* FOR DANGEROUS GOODS: you must specify: UN No., proper shipping name, hazard class, packing group (where assigned) and any other element of information required under applicable national and international regulations.

Chapter 5.5

Special provisions

5.5.1 (Deleted)

5.5.2 Special provisions applicable to fumigated cargo transport units (UN 3359)

5.5.2.1 General

5.5.2.1.1 Fumigated cargo transport units (UN 3359) containing no other dangerous goods are not subject to any provisions of RID other than those of this section.

NOTE: For the purposes of this Chapter, cargo transport unit means a wagon, a container, a tank-container, a portable tank or a MEGC.

5.5.2.1.2 When the fumigated cargo transport unit is loaded with dangerous goods in addition to the fumigant, any provision of RID relevant to these goods (including placarding, marking and documentation) applies in addition to the provisions of this section.

5.5.2.1.3 Only cargo transport units that can be closed in such a way that the escape of gas is reduced to a minimum shall be used for the carriage of cargo under fumigation.

5.5.2.2 Training

Persons engaged in the handling of fumigated cargo transport units shall be trained commensurate with their responsibilities.

5.5.2.3 Marking and placarding

5.5.2.3.1 A fumigated cargo transport unit shall be marked with a warning mark, as specified in 5.5.2.3.2, affixed at each access point in a location where it will be easily seen by persons opening or entering the cargo transport unit. This mark shall remain on the cargo transport unit until the following provisions are met:

- (a) The fumigated cargo transport unit has been ventilated to remove harmful concentrations of fumigant gas; and
- (b) The fumigated goods or materials have been unloaded.

5.5.2.3.2 The fumigation warning mark shall be rectangular and shall not be less than 300 mm wide and 250 mm high. The markings shall be in black print on a white background with lettering not less than 25 mm high. An illustration of this mark is given in the figure below.

Fumigation warning mark

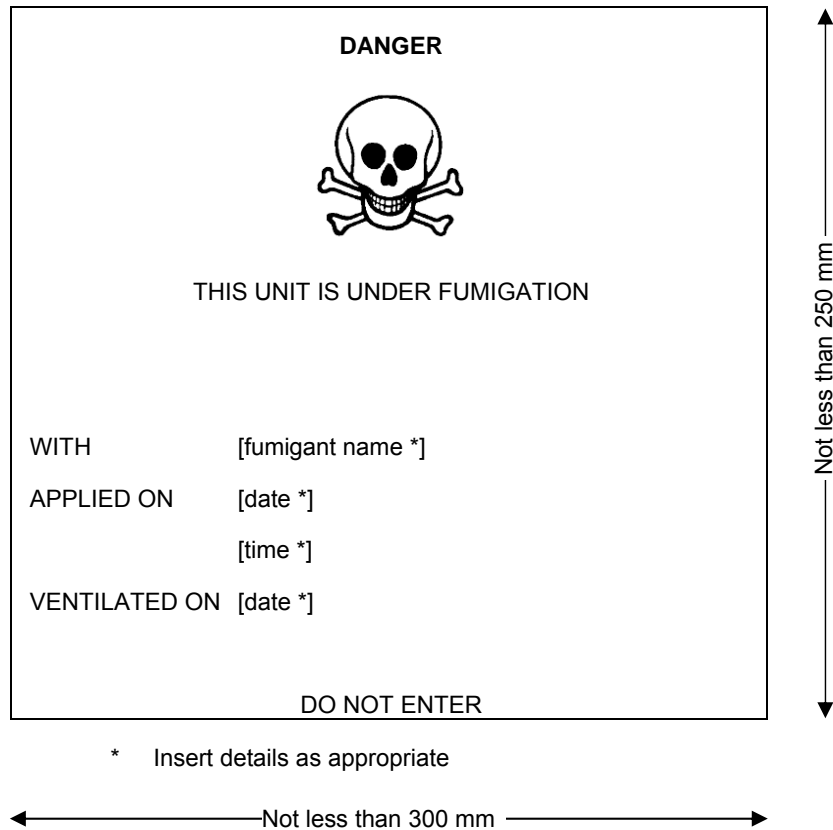

5.5.2.3.3 If the fumigated cargo transport unit has been completely ventilated either by opening the doors of the unit or by mechanical ventilation after fumigation, the date of ventilation shall be marked on the fumigation warning mark.

5.5.2.3.4 When the fumigated cargo transport unit has been ventilated and unloaded, the fumigation warning mark shall be removed.

5.5.2.3.5 Placards conforming to model No. 9 (see 5.2.2.2.2) shall not be affixed to a fumigated cargo transport unit except as required for other Class 9 substances or articles packed therein.

5.5.2.4 Documentation

5.5.2.4.1 Documents associated with the carriage of cargo transport units that have been fumigated and have not been completely ventilated before carriage shall include the following information:

- "UN 3359 fumigated cargo transport unit, 9", or "UN 3359 fumigated cargo transport unit, Class 9";
- The date and time of fumigation; and
- The type and amount of the fumigant used.

These particulars shall be drafted in an official language of the forwarding country and also, if the language is not English, French, German or Italian, in English, French, German or Italian, unless agreements, if any, concluded between the countries concerned in the transport operation provide otherwise.

5.5.2.4.2 The documents may be in any form, provided they contain the information required in 5.5.2.4.1. This information shall be easy to identify, legible and durable.

5.5.2.4.3 Instructions for disposal of any residual fumigant including fumigation devices (if used) shall be provided.

5.5.2.4.4 A document is not required when the fumigated cargo transport unit has been completely ventilated and the date of ventilation has been marked on the warning mark (see 5.5.2.3.3 and 5.5.2.3.4).